

SERVICE MANUAL

HP 16500A LOGIC ANALYSIS SYSTEM



HP 16500A

LOGIC ANALYSIS SYSTEM
MAINFRAME

Service Manual



 **HEWLETT
PACKARD**



SERVICE MANUAL

HP MODEL 16500A LOGIC ANALYSIS SYSTEM MAINFRAME

SERIAL NUMBERS

This manual applies directly to instruments
with serial numbers prefixed 2650A.

For additional information about serial numbers see
INSTRUMENTS COVERED BY THIS MANUAL
in Section I.

© COPYRIGHT HEWLETT-PACKARD COMPANY/COLORADO SPRINGS DIVISION 1987
1900 GARDEN OF THE GODS ROAD, COLORADO SPRINGS, COLORADO, U.S.A.

ALL RIGHTS RESERVED

Printed in U.S.A. September 1987

Manual Part Number 16500-90901
Microfiche Part Number 16500-90801

CERTIFICATION

Hewlett-Packard Company certifies that this product met its published specifications at the time of shipment from the factory. Hewlett-Packard further certifies that its calibration measurements are traceable to the United States National Bureau of Standards, to the extent allowed by the Bureau's calibration facility, and to the calibration facilities of other International Standards Organization members.

WARRANTY

This Hewlett-Packard product is warranted against defects in material and workmanship for a period of one year from date of shipment. During the warranty period, Hewlett-Packard Company will, at its option, either repair or replace products which prove to be defective.

For warranty service or repair, this product must be returned to a service facility designated by HP. Buyer shall prepay shipping charges to HP and HP shall pay shipping charges to return the product to Buyer. However, Buyer shall pay all shipping charges, duties, and taxes for products returned to HP from another country.

HP warrants that its software and firmware designated by HP for use with an instrument will execute its programming instructions when properly installed on that instrument. HP does not warrant that the operation of the instrument or software, or firmware will be uninterrupted or error free.

LIMITATION OF WARRANTY

The foregoing warranty shall not apply to defects resulting from improper or inadequate maintenance by Buyer, buyer-supplied software or interfacing, unauthorized modification or misuse, operation outside the environmental specifications for the product, or improper site preparation or maintenance.

NO OTHER WARRANTY IS EXPRESSED OR IMPLIED. HP SPECIFICALLY DISCLAIMS THE IMPLIED WARRANTIES OF MERCHANTABILITY AND FITNESS FOR A PARTICULAR PURPOSE.

EXCLUSIVE REMEDIES

THE REMEDIES PROVIDED HEREIN ARE BUYER'S SOLE AND EXCLUSIVE REMEDIES. HP SHALL NOT BE LIABLE FOR ANY DIRECT, INDIRECT, SPECIAL, INCIDENTAL, OR CONSEQUENTIAL DAMAGES, WHETHER BASED ON CONTRACT, TORT, OR ANY OTHER LEGAL THEORY.

ASSISTANCE

Product maintenance agreements and other customer assistance agreements are available for Hewlett-Packard products.

For any assistance, contact your nearest Hewlett-Packard Sales and Service Office. Addresses are provided at the back of this manual.

SAFETY CONSIDERATIONS

GENERAL - This is a Safety Class I instrument (provided with terminal for protective earthing).

OPERATION - BEFORE APPLYING POWER verify that the power transformer primary is matched to the available line voltage, the correct fuse is installed, and Safety Precautions are taken (see the following warnings). In addition, note the instrument's external markings which are described under "Safety Symbols."

WARNING

o Servicing instructions are for use by service-trained personnel. To avoid dangerous electric shock, do not perform any servicing unless qualified to do so.

o BEFORE SWITCHING ON THE INSTRUMENT, the protective earth terminal of the instrument must be connected to the protective conductor of the (mains) powercord. The mains plug shall only be inserted in a socket outlet provided with a protective earth contact. The protective action must not be negated by the use of an extension cord (power cable) without a protective conductor (grounding). Grounding one conductor of a two-conductor outlet is not sufficient protection.

o If this instrument is to be energized via an auto-transformer (for voltage reduction) make sure the common terminal is connected to the earth terminal of the power source.

o Any interruption of the protective (grounding) conductor (inside or outside the instrument) or disconnecting the protective earth terminal will cause a potential shock hazard that could result in personal injury.

o Whenever it is likely that the protection has been impaired, the instrument must be made inoperative and be secured against any unintended operation.

o Only fuses with the required rated current, voltage, and specified type (normal blow, time delay, etc.) should be used. Do not use repaired fuses or short circuited fuseholders. To do so could cause a shock or fire hazard.

o Do not operate the instrument in the presence of flammable gasses or fumes. Operation of any electrical instrument in such an environment constitutes a definite safety hazard.

o Do not install substitute parts or perform any unauthorized modification to the instrument.

o Adjustments described in the manual are performed with power supplied to the instrument while protective covers are removed. Energy available at many points may, if contacted, result in personal injury.

o Any adjustment, maintenance, and repair of the opened instrument under voltage should be avoided as much as possible, and when inevitable, should be carried out only by a skilled person who is aware of the hazard involved.

o Capacitors inside the instrument may still be charged even if the instrument has been disconnected from its source of supply.

SAFETY SYMBOLS



Instruction manual symbol. The product will be marked with this symbol when it is necessary for the user to refer to the instruction manual in order to protect against damage to the product.



Indicates hazardous voltages.



Earth terminal (sometimes used in manual to indicate circuit common connected to grounded chassis).

WARNING

The WARNING sign denotes a hazard. It calls attention to a procedure, practice, or the like, which, if not correctly performed or adhered to, could result in personal injury. Do not proceed beyond a WARNING sign until the indicated conditions are fully understood and met.

CAUTION

The CAUTION sign denotes a hazard. It calls attention to an operating procedure, practice, or the like, which, if not correctly performed or adhered to, could result in damage to or destruction of part or all of the product. Do not proceed beyond a CAUTION sign until the indicated conditions are fully understood or met.

TABLE OF CONTENTS

Section	Page
I. GENERAL INFORMATION	1-1
1-1. Introduction	1-1
1-2. Instruments Covered By Manual	1-1
1-3. Safety Considerations	1-1
1-4. Product Description	1-2
1-5. Accessories Supplied	1-2
1-6. Accessories Available	1-2
1-7. Operating Characteristics	1-2
1-8. Recommended Test Equipment	1-6
II. INSTALLATION	2-1
2-1. Introduction	2-1
2-2. Safety Considerations	2-1
2-3. Initial Inspection	2-1
2-4. Operating Disc Installation	2-1
2-5. Power Requirements	2-1
2-6. Line Voltage Selection	2-1
2-7. Power Cable	2-2
2-8. User Interface	2-4
2-9. The Touchscreen	2-4
2-10. The Front Panel Knob	2-4
2-11. The HP Mouse	2-4
2-12. HP-IB Interfacing	2-5
2-13. HP-IB Address Selection	2-5
2-14. HP-IB Address Codes	2-7
2-15. HP-IB Interface Functions	2-8
2-16. RS-232-C Interface	2-8
2-17. Baud Rate Selection	2-10
2-18. Degaussing the Display	2-12
2-19. Operating Environment	2-12
2-20. Storage and Shipment	2-12
2-21. Packaging	2-12
2-22. Tagging for Service	2-12
III. PERFORMANCE TESTS	3-1
3-1. Introduction	3-1

TABLE OF CONTENTS

IV. ADJUSTMENTS

4-1. Introduction	4-1
4-2. Degaussing the Display	4-1
4-3. Safety Considerations	4-1
4-4. Adjustment Test Patterns	4-2
4-5. Color Module Adjustment	4-7

V REPLACEABLE PARTS

5-1. Introduction	5-1
5-2. Abbreviations	5-1
5-3. Replaceable Parts List	5-1
5-4. Exchange Assemblies	5-1
5-5. Ordering Information	5-1
5-6. Direct Mail Order System	5-2

VI. SERVICE

6-1. Introduction	6-1
6-2. Safety Considerations	6-1
6-3. Service Test Equipment Required	6-1
6-4. Theory of Operation	6-1
6-5. System Overview	6-3
6-6. Microprocessor Board Theory	6-5
6-7. Power Up Tests	6-6
6-8. Mainframe Test System	6-7
6-9. Troubleshooting	6-16
6-10. Repair	6-29
6-11. Power Supply Replacement	6-30
6-12. Microprocessor Board Replacement	6-33
6-13. Mother Board Replacement	6-35
6-14. Front Panel Board Replacement	6-37
6-15. Display Module Replacement	6-39
6-16. Front Disc Drive replacement	6-44
6-17. Rear Disc Drive Replacement	6-45
6-18. Cooling Fan Replacement	6-46

LIST OF TABLES

Table	Title	Page
1-1.	Operating Characteristics	1-3
1-2.	Recommended Test Equipment	1-6
2-1.	HP-IB Address Settings	2-7
2-2.	Model 16500A HP-IB Functions	2-8
2-3.	RS-232-C Signal Definitions	2-9
5-1.	Reference Designators and Abbreviations	5-3
5-2.	Replaceable Parts	5-5
6-1.	Replaceable Assemblies	6-29

LIST OF ILLUSTRATIONS

Figure	Title	Page
1-1.	HP Model 16500A Dimensional Detail	1-5
2-1.	Line Voltage Selection	2-2
2-2.	Power Cord Configurations	2-3
2-3.	HP 16500A User Interface Devices	2-4
2-4.	HP-IB Interface Connector	2-5
2-5.	System Configuration Menu	2-6
2-6.	HP-IB Configuration Menu	2-6
2-7.	HP-IB Configuration with Keypad	2-7
2-8.	System Configuration with optional Mouse	2-10
2-9.	RS-232-C Configuration Menu	2-10
2-10.	Baud Rate Pop-up Menu	2-11
4-1.	System Configuration Menu	4-2
4-2.	Accessing the System	4-2
4-3.	Loading the Test System	4-3
4-4.	Test System Configuration	4-3
4-5.	Selecting Mainframe Test Menu	4-4
4-6.	Mainframe Test Menu	4-4
4-7.	Selecting the Test Patterns	4-5

LIST OF ILLUSTRATIONS

4-8.	Exiting the Mainframe Test System	4-5
4-9.	Exiting the Test System	4-6
4-10.	System Configuration	4-6
4-11.	CRT Module Adjustment Flow Chart	4-8
4-12.	PIN AMP Adjustment	4-9
4-13.	Bottom Rail Removal	4-10
4-14.	PIN PHASE Adjustment	4-10
4-15.	Purity Magnet Centering	4-13
4-16.	Purity Magnet Adjustment Raster	4-14
4-17.	Landing and Purity Adjustment	4-15
4-18.	Static Convergence	4-16
4-19.	Y BOW Adjustment	4-17
4-20.	Y BOW CROSS Adjustment	4-17
4-21.	V.STAT TOP Adjustment	4-18
4-22.	V.STAT BOTTOM Adjustment	4-18
4-23.	H.AMP Adjustment	4-19
4-24.	H.TILT Adjustment	4-19
5-1.	Electrical Assembly Identification	5-4
5-2.	Chassis Parts Identification	5-6
6-1.	System Overview	6-2
6-2.	Microprocessor Block Diagram	6-4
6-3.	System Configuration	6-7
6-4.	Accessing the Test System	6-7
6-5.	Loading the Test System Software	6-8
6-6.	Test System Configuration	6-8
6-7.	Mainframe Test Menu	6-8
6-8.	All System Test	6-9
6-9.	Selecting the Color Display Test Patterns	6-10
6-10.	Mainframe Test Menu	6-11
6-11.	ROM Test Screen	6-11
6-12.	Choosing the Single or Repetitive Mode	6-12
6-13.	ROM Test in the Repetitive Mode	6-12
6-14.	Exiting the Mainframe Test System	6-13
6-15.	Exiting Mainframe Configuration	6-13
6-16.	Reloading the Mainframe System	6-14
6-17.	HP 16500A Power-up Test	6-16
6-18.	Main Troubleshooting Flow Chart	6-17
6-19.	Color Module Troubleshooting Flow Chart	6-18
6-20.	Checking for Color module Signals	6-20
6-21.	System Boot Troubleshooting Flow Chart	6-21

LIST OF ILLUSTRATIONS

6-22.	Power Supply Troubleshooting Flow Chart	6-22
6-23.	Power Supply Check	6-23
6-24.	Checking Power supply Resistance to Ground	6-24
6-25.	HIL Troubleshooting Flow Chart	6-25
6-26.	Disc Drive Troubleshooting Flow Chart	6-26
6-27.	RS-232-C Troubleshooting Flow Chart	6-27
6-28.	Intermodule Troubleshooting Flow Chart	6-28
6-29.	Replaceable Assembly Identification	6-29
6-30.	Power Supply Rear Panel	6-30
6-31.	Power Supply Mounting Screws and Display Power Cable	6-31
6-32.	Power Supply Connector Alignment	6-31
6-33.	Power Supply Rail Alignment	6-32
6-34.	Microprocessor Cable Location	6-33
6-35.	Microprocessor Board Mounting Screws	6-33
6-36.	Power Supply and Microprocessor Hardware Identification	6-35
6-37.	Microprocessor Board Removal	6-36
6-38.	Mother Board Removal	6-36
6-39.	Front Panel Cable Removal	6-37
6-40.	Front Panel Mounting Screws Identification	6-37
6-41.	Front Panel Board Hardware Identification	6-38
6-42.	Front Panel Mounting Screws Identification	6-39
6-43.	Module Bracket Mounting Hardware	6-40
6-44.	Center Board Guide Hardware	6-40
6-45.	Display Module Rear Mounting Bracket	6-41
6-46.	Display Module Rear Mounting Bracket Assembly	6-42
6-47.	Final Positioning of Front Panel and Display Module	6-43
6-48.	Front Disc Removal	6-44
6-49.	Front Disc Drive Replacement	6-44
6-50.	Rear Disc Drive Removal	6-45
6-51.	Side Fan Mounting Screws and Power Cable Removal	6-46
6-52.	Rear Fan Removal	6-47

TABLE OF CONTENTS

GENERAL INFORMATION

1-1. Introduction	1-1
1-2. Instruments Covered by Manual	1-1
1-3. Safety Considerations	1-1
1-4. Product Description	1-2
1-5. Accessories Supplied	1-2
1-6. Accessories Available	1-2
1-7. Operating Characteristics	1-2
1-8. Recommended Test Equipment	1-6

SECTION I

GENERAL INFORMATION

1-1. INTRODUCTION

This Service Manual explains how to test, adjust, and service the Hewlett-Packard 16500A Logic Analysis System mainframe. This manual is divided into six sections as follows:

- 1 - General Information
- 2 - Installation
- 3 - Performance Tests
- 4 - Adjustments
- 5 - Replaceable Parts
- 6 - Service

Information for operating, programming, and interfacing the Model 16500A is contained in the HP 16500A Operating and Programming manual set supplied with each instrument.

The General Information Section includes a description of the HP Model 16500A, its specifications, options, available accessories, and recommended test equipment for maintaining the instrument.

Also listed on the title page of this manual is a Microfiche part number. This number can be used to order 4 X 6 inch microfilm transparencies of the manual. Each microfiche contains up to 96 photo-duplicates of the manual pages. The microfiche package also includes the latest Manual Changes supplement and pertinent Service Notes.

Shipped with this manual are service manuals for each module ordered with the the HP 16500A. To complete the service documentation for your system, unpack the module service manuals and place them in the 3-ring binder of this manual.

1-2. INSTRUMENTS COVERED BY MANUAL

The instrument serial number is on the rear panel. Hewlett-Packard uses a two-part serial number consisting of a four-digit prefix and a five-digit suffix separated by a letter (**0000A00000**). The prefix is the same for all identical instruments and changes only when a modification is made that affects parts compatibility. The suffix is assigned and is different for each instrument. This manual applies directly to instruments with the serial prefix shown on the title page.

An instrument manufactured after the printing of this manual may have a serial number prefix that is not listed on the title page. This unlisted serial prefix indicates the instrument is different from those described in this manual. The manual for this newer instrument is accompanied by a Manual Changes supplement. This supplement contains "change information" that explains how to adapt the manual to the newer instrument.

In addition to change information, the supplement may contain information for correcting errors in the manual. To keep this manual as current and accurate as possible, Hewlett-Packard recommends that you periodically request the latest Manual Changes supplement. The supplement for this manual is identified with the manual print date and part number, both of which appear on the manual title page. Complimentary copies of the supplement are available from Hewlett-Packard.

1-3. SAFETY CONSIDERATIONS

This product is a Safety Class 1 instrument (provided with a protective earth terminal). Review the instrument and manual for safety markings and instructions before operating. Specific warnings, cautions, and instructions are placed wherever applicable throughout the

manual. These precautions must be observed during all phases of operation, service, and repair of the instrument. Failure to comply with these precautions or with specific warnings elsewhere in this manual violates safety standards of design, manufacture, and intended use of this instrument.

Hewlett-Packard assumes no liability for the customer's failure to comply with these safety requirements.

1-4. PRODUCT DESCRIPTION

The HP Model 16500A is the mainframe of the logic analysis system. It is of modular structure using plug-in cards with a wide range of data acquisition and stimulus cards. This allows the user to configure the system with only the necessary modules for a particular application.

Some of the key features of the HP 16500A are:

- Modular mainframe with five card slots.
- Nine inch color monitor.
- The touchscreen user interface.
- Dual 3.5 inch floppy disc drives.
- Intermodule triggering and time correlation of acquired data.
- HP-IB and RS-232-C Interfaces for hardcopy output to a printer or controller interface.

1-5. ACCESSORIES SUPPLIED

The following accessories are supplied with the HP Model 16500A:

- 1 Power cord
- 1 Operating and Reference manual set
- 1 Service manual
- Rear panel filler panels depending on how many modules are ordered with HP Model 16500A
- 1 Operating System Disc
- 1 Blank Disc

1-6. ACCESSORIES AVAILABLE

The following optional accessories are available for the HP Model 16500A:

- HP 46060A Mouse
- HP 16510A State/Timing Analyzer
- HP 16515A/16516A 1 GHz Timing Analyzer
- HP 16520A/16521A Pattern Generator
- HP 16530A/16531A Digitizing Oscilloscope

- HP 2225A ThinkJet Printer (HP-IB Interface)
- HP 10833A/B/C/D HP-IB Cable
- HP 2225D ThinkJet Printer (RS-232-C Interface)
- RS-232-C DTE to DTE cable for connecting the HP 16500A to printers and controllers. HP Part No. 13242-60010.
- RS-232-C DTE to DCE cable for connecting the HP 16500A to modems and data switches. HP Part No. 13242-60001.

- HP 1008A Testmobile (Option 006)
- HP 74240A/B CAE Software
- Rackmount Kit HP Part No. 5061-9679
- Service Data Supplement

1-7. OPERATING CHARACTERISTICS

Table 1-1 is a listing of the instrument's operating characteristics. These are not specifications, but are typical operating characteristics included as additional information for the user.

Table 1-1. HP Model 16500A Operating Characteristics

BUILT-IN DISC DRIVES

File Types: System software; configuration (contains instrument configuration, data, pointer to inverse assembler file); inverse assembler; auto-configuration, calibration.

Autoload Designation: A predefined configuration file can be loaded at power-up.

Disc Operations: Store, load, copy, duplicate disc, pack disc, rename, purge, and format disc.

PROGRAMMABILITY

Instrument settings and operating modes, including automatic measurements, may be remotely programmed via RS-232-C or HP-IB (IEEE-488).

HARDCOPY OUTPUT

Printers Supported: HP ThinkJet, HP QuietJet, HP LaserJet, HP PaintJet, Epson and Epson-compatible (e. g. Epson FX-80) via RS-232-C or HP-IB.

RS-232-C Configurations: Protocols: XON/XOFF, Hardware; Data bits: 7, 8; Stop bits: 1, 1 1/2, 2; Parity: none, odd, or even; Baud rates: 110, 300, 600, 1200, 2400, 4800, 9600, 19200.

INPUT/OUTPUT REAR PANEL BNCs:

Input BNC: Labeled Port-in. Input signal must drive four LS TTL loads, active high.

Output BNC: Labeled Port-out. Output signal is active high, TTL output level: high \geq 2V into 50 Ohms, low \leq 0.4V into 50 Ohms.

Table 1-1. HP Model 16500A Operating Characteristics (Continued)

OPERATING ENVIRONMENT

Temperature:

Instrument: 0°C to 55°C (+32°F to 131°F).

Disc Media: 10°C to 50°C (+50°F to 122°F).

Probes and Cables: 0°C to 65°C (+32°F to 149°F).

Humidity:

Instrument: up to 95% relative humidity at 40°C (104°F)

Disc media: 8% to 80% relative humidity at 40°C (104°).

Altitude:

Up to 4600 m (15 000 ft).

Vibration:

Operating: Random vibration 5-500Hz, 10 minutes per axis, ~ 0.3g (rms).

Non-operating: Random vibration 5-500Hz, 10 minutes per axis, ~ 2.4 g (rms); and swept sine resonant search, 5-500Hz, 0.75g (0-peak), 5 minute dwell @ 4 resonances per axis.

WEIGHT

Net: 18.1 kg (40 lbs) + 0.7 kg (1.6lbs) x number of optional cards installed.

Shipping: 25.9 kg (57 lbs) + 3.6 kg (8 lbs) x number of optional cards installed.

POWER REQUIREMENTS:

115V/230V, 48 to 66Hz, 475W max

DIMENSIONS:

Refer to figure 1-1 for dimensional detail.

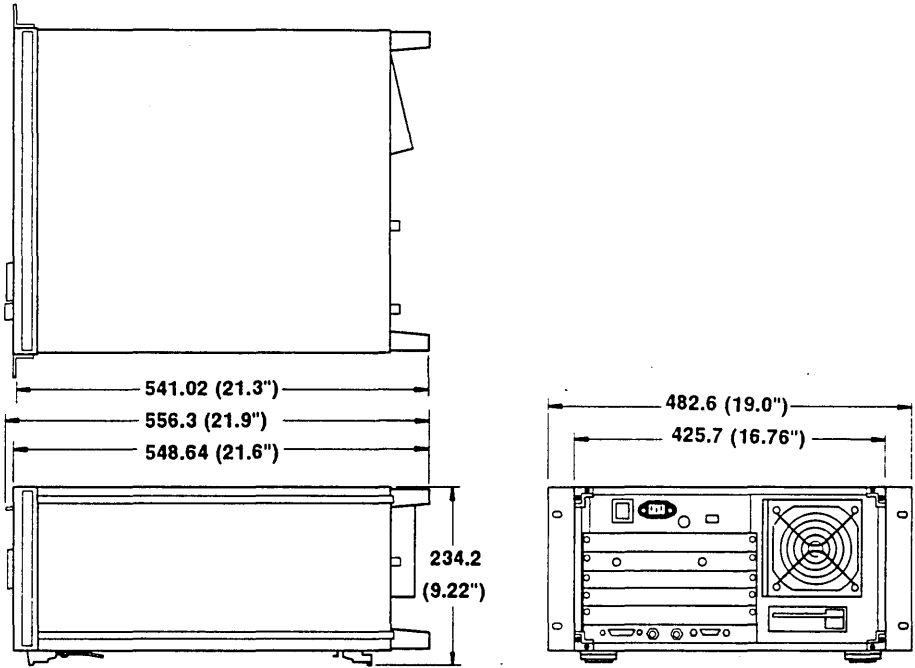

Figure 1-1. HP Model 16500A Dimensional Detail

1-8. RECOMMENDED TEST EQUIPMENT

Equipment required to test and maintain the HP Model 16500A is listed in table 1-2.

Other equipment may be substituted if it meets or exceeds the critical specifications listed in the table.

Table 1-2. Recommended Test Equipment.

INSTRUMENT TYPE	RECOMMENDED MODEL	REQUIRED CHARACTERISTICS	REQUIRED FOR
OSCILLOSCOPE	HP MODEL 54201A WITH PROBES	BANDWIDTH 100MHz	T
RS 232-C LOOP BACK CONNECTOR	HP PART NO. 01650-63202		T
VOLTMETER	HP MODEL 3468A	3 1/2 DIGIT RESOLUTION	T

A = Adjustments, P = Performance Verification, T = Troubleshooting

TABLE OF CONTENTS

INSTALLATION

2-1. Introduction	2-1
2-2. Safety Considerations	2-1
2-3. Initial Inspection	2-1
2-4. Operating Disc Installation	2-1
2-5. Power Requirements	2-1
2-6. Line Voltage Selection	2-1
2-7. Power Cable	2-2
2-8. User Interface	2-4
2-9. The Touchscreen	2-4
2-10. The Front Panel Knob	2-4
2-11. The HP Mouse	2-4
2-12. HP-IB Interfacing	2-5
2-13. HP-IB Address Selection	2-5
2-14. HP-IB Address Codes	2-7
2-15. HP-IB Interface Functions	2-8
2-16. RS-232-C Interface	2-8
2-17. Baud Rate Selection	2-10
2-18. Degaussing the Display	2-12
2-19. Operating Environment	2-12
2-20. Storage and Shipment	2-12
2-21. Packaging	2-12
2-22. Tagging for Service	2-12

SECTION II INSTALLATION

2-1. INTRODUCTION

This section explains how to install the HP Model 16500A Logic Analysis System, inspect it, prepare it for use, store and ship it.

2-2. SAFETY CONSIDERATIONS

The safety symbols used with Hewlett-Packard instruments are illustrated in the front matter of this manual. WARNING and CAUTION symbols and instructions should be reviewed before operating the instrument. These warnings and cautions must be followed for your own protection and to avoid damage to the instrument.

2-3. INITIAL INSPECTION

Inspect the shipping container for damage. If the shipping container or cushioning material is damaged, it should be kept until the contents of the shipment have been checked for completeness and the instrument has been checked mechanically and electrically. The contents of the shipment should be as listed in the "Accessories Supplied" paragraph in Section I. If the contents are incomplete, or if there is mechanical damage, notify the nearest Hewlett-Packard office. If the shipping container is damaged, or the cushioning material shows signs of stress, notify the carrier as well as the Hewlett-Packard office. Keep the shipping material for carrier's inspection. The HP office will arrange for repair or replacement at HP option without waiting for claim settlement.

2-4. OPERATING DISC INSTALLATION

The instrument is shipped with yellow protective discs in each disc drive. Before applying power to the mainframe, remove the protective discs from the front and rear disc drives and install the operating disc in one of the disc drives. Reinstall the protective discs whenever the instrument is transported.

2-5. POWER REQUIREMENTS

The HP Model 16500A requires a power source of either 115 Vac or 230 Vac, 48 to 66 Hz, 475 W maximum.

2-6. LINE VOLTAGE SELECTION

CAUTION

The instrument may be damaged if the Line Voltage Select switch is not properly set.

When shipped from the factory, the Line Select switch is set and an appropriate fuse is installed for operating the instrument in the country of destination.

To operate the instrument from a power source other than the one set at the factory, proceed as follows:

1. Turn front panel switch to STBY and rear panel power switch to OFF. Remove power cord from instrument.
2. Replace the main fuse with a 5A/250 V for 230 V operation, or a 10 A/250 V fuse for 115 V operation.
3. Set rear panel Line Select switch for desired line voltage.
4. Reconnect power cord, turn on rear panel power switch and continue normal operation.

2-7. POWER CABLE

This instrument is equipped with a three-wire power cable. When connected to an appropriate AC power outlet, this cable grounds the instrument cabinet. The type of power cable plug shipped with the instrument depends on the country of destination. See figure 2-2 for option numbers of available power cables and plug configurations.

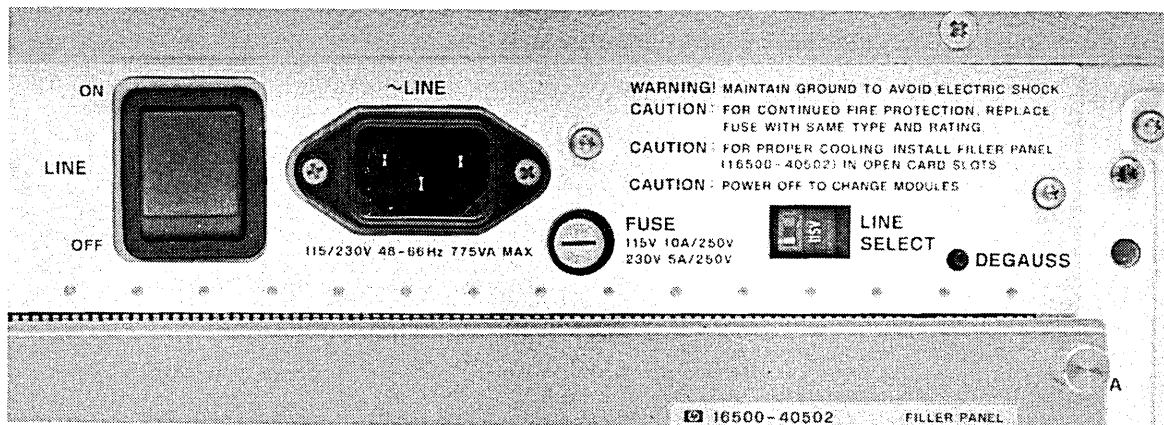
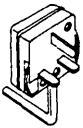

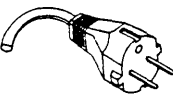
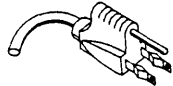
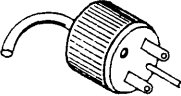
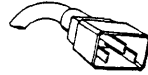
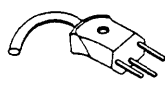
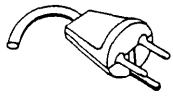

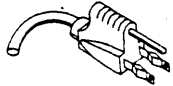

Figure 2-1. Line Voltage Selection

Figure 2-2. Power Cord Configurations

PLUG TYPE	CABLE PART NO.	PLUG DESCRIPTION	LENGTH IN/CM	COLOR	COUNTRY
OPT 250V 900 	8120-1351 8120-1703	Straight *BS1363A 90°	90/228 90/228	Gray Mint Gray	United Kingdom, Cyprus, Nigeria, Zimbabwe, Singapore
OPT 250V 901 	8120-1369 8120-0696	Straight *NZSS198/ASC 90°	79/200 87/221	Gray Mint Gray	Australia, New Zealand
OPT 250V 902 	8120-1689 8120-1692 8120-2857	Straight *CEE7-Y11 90° Straight (Shielded)	79/200 79/200 79/200	Mint Gray Mint Gray Coco Brown	East and West Europe, Saudi Arabia, So. Africa, India (Unpolarized in many nations)
OPT** 125V 903 	8120-1378 8120-1521 8120-1992	Straight *NEMA5-15P 90° Straight (Medical) UL544	90/228 90/228 96/244	Jade Gray Jade Gray Black	United States, Canada, Mexico, Philippines, Taiwan,
OPT** 250V 904 	8120-0698	Straight *NEMA6-15P	90/228	Black	United States, Canada
OPT 250V 905 	8120-1396 8120-1625	CEE22-V1 (System Cabinet Use) 250V	30/76 96/244	Jade Gray	For interconnecting system components and peripherals. United States and Canada only
OPT 250V 906 	8120-2104 8120-2296	Straight *SEV1011 1959-24507 Type 12 90°	79/200 79/200	Mint Gray Mint Gray	Switzerland
OPT 220V 912 	8120-2956 8120-2957	Straight *DHCK107 90°	79/200 79/200	Mint Gray Mint Gray	Denmark
OPT 250V 917 	8120-4600 8120-4211	Straight SABS164 90°	79/200 79/200	Jade Gray	Republic of South Africa India
OPT 100V 918 	8120-4753 8120-4754	Straight Miti 90°	90/230 90/230	Dark Gray	Japan

*Part number shown for plug is industry identifier for plug only. Number shown for cable is HP Part Number for complete cable including plug.

**These cords are included in the CSA certification approval of the equipment.

E = Earth Ground

L = Line

N = Neutral

2-8. USER INTERFACE

Three devices may be used to interface with the HP 16500A and all installed modules:

the Touch Screen, the front panel Knob, and the optional HP Mouse (see figure 2-3).

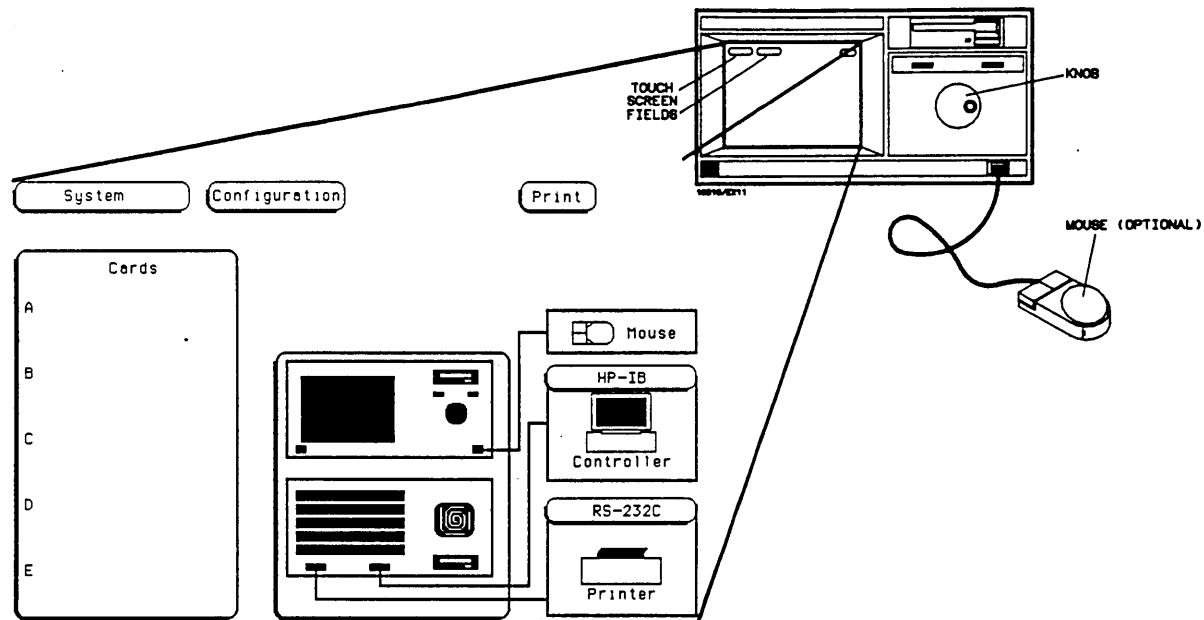

Figure 2-3. HP 16500A User Interface Devices.

2-9. The Touchscreen.

The Touchscreen interface provides the main front panel control or access to the menus. By touching the appropriate field, you can access other menus, configure the HP 16500A for making measurements, and enter or change alpha numeric data.

in the same way as the Touchscreen and the Knob. Moving it about on a hard flat surface will move the cursor (+) over the entire screen. To select a field, connect the mouse to the front panel HIL connector and move the HP Mouse until the cursor rests in the desired field. Press the left button to complete the selection of the field. To duplicate the Knob function, press and hold the right button of the HP Mouse and move it over the desktop. When the correct numerical value or the correct function has been selected, stop moving the HP Mouse and release the right button.

2-10. The Front Panel Knob

The front panel Knob is used to increment or decrement numeric fields and to roll the display. Rolling the display means scrolling through information on screen.

For complete operating information refer to the HP 16500A and module operating manuals.

2-11. The HP Mouse

The HP Mouse is an optional user interface accessory (HP Model 46060A). The HP mouse functions

2-12. HP-IB INTERFACING

The Hewlett-Packard Interface Bus (HP-IB) is Hewlett-Packard's implementation of IEEE Standard 488-1978, "Standard Digital Interface for Programmable Instrumentation." HP-IB is a carefully defined interface that simplifies the integration of various instruments and computers into systems. The interface makes it possible to transfer messages between two or more HP-IB compatible devices. HP-IB is a parallel bus of 16 active signal lines divided into three functional groups according to function.

Eight signal lines, called data lines, are in the first functional group. The data lines are used to transmit data in coded messages. These messages are used to program the instrument function, transfer measurement data, and coordinate instrument operation. Input and output of all messages, in bit parallel-byte serial form, are also transferred on the data lines. A 7-bit ASCII code normally represents each piece of data.

Data is transferred by means of an interlocking "handshake" technique which permits data transfer (asynchronously) at the rate of the slowest active device used in that transfer. The data byte control lines coordinate the handshaking and form the second functional group.

The remaining five general interface management lines (third functional group) are used to manage the devices connected to the HP-IB. This includes activating all connected devices at once, clearing the interface and other operations.

The connections to the HP-IB connector on the rear panel are shown in figure 2-4.

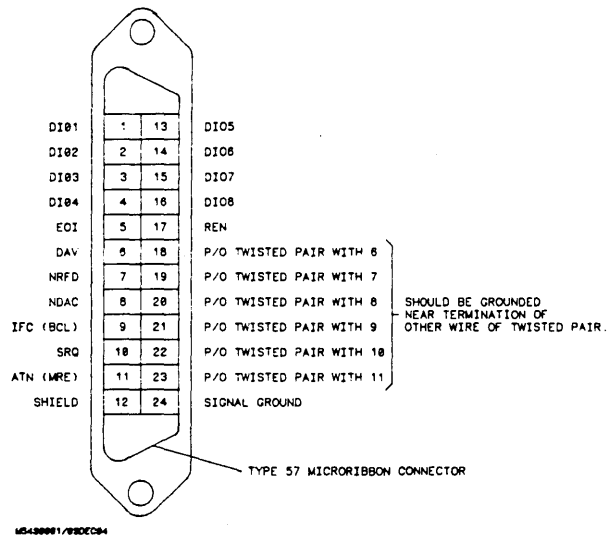

Figure 2-4. HP-IB Interface Connector.

2-13. HP-IB ADDRESS SELECTION

Each instrument connected to the HP-IB interface bus requires a unique address. The address provides a method for the system computer to select individual instruments on the bus. The address of the HP Model 16500A defaults at power on to decimal "07". The corresponding ASCII code is a listen of "" and a talk address of "G". To change the address of the HP 16500A proceed as follows:

1. Cycle power or touch the upper left corner field. Touch the **System** field to obtain the System Configuration menu (see figure 2-5).

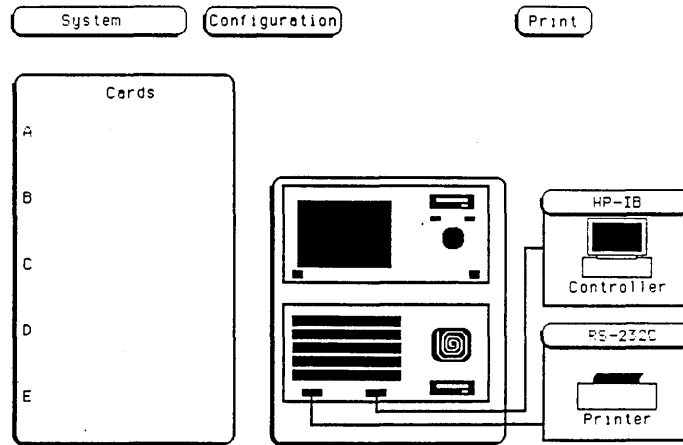

Figure 2-5. System Configuration menu.

2. Touch **HP-IB** field to call up the HP-IB Configuration Menu (see figure 2-6).

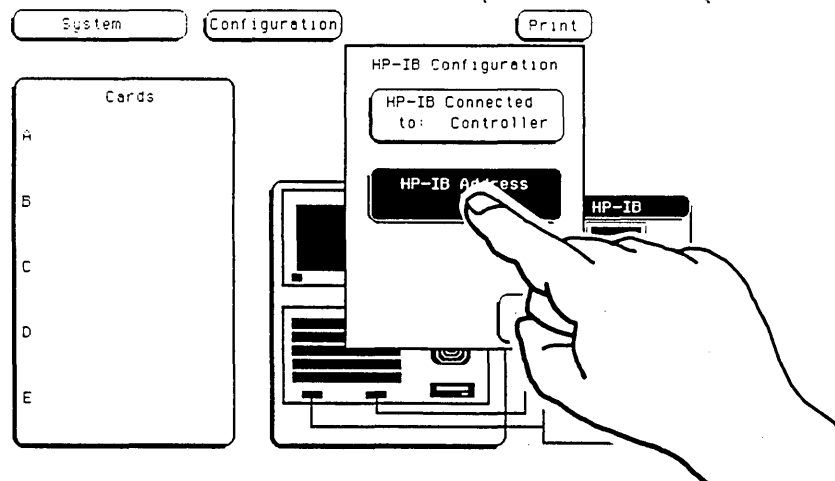

Figure 2-6. HP-IB Configuration Menu.

3. Rotate knob to select the desired HP-IB address. The address number is shown in the HP-IB Address field. The address number may also be entered via the keypad. Touch the **HP-IB** field again to bring up the keypad. Select the new number using the keypad

and touch **Done** to enter the new selected address (see figure 2-7).
4. Touch **Done** to exit the HP-IB Configuration menu.

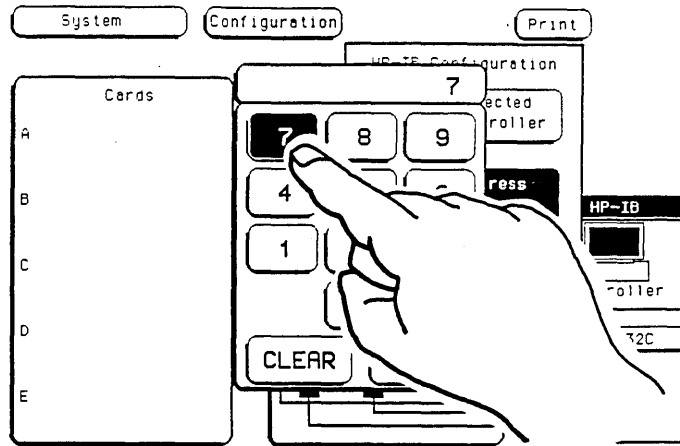

Figure 2-7. HP-IB Configuration with Keypad.

2-14. HP-IB ADDRESS CODES

The following table lists the address codes and the address characters used to direct talk and listen activities. To use this table,

simply identify the address code of the device to where you wish to send a command. Use the ASCII address characters to direct talk/listen activities and the "?" character to unaddress all devices on the bus.

Table 2-1. HP-IB Address Settings.

ASCII Characters		HP 16500A HP-IB Address Setting
Listen	Talk	
SP	@	0
!	A	1
"	B	2
#	C	3
\$	C	4
%,	E	5
&	F	6
'	G	7 ← Preset at power on
(H	8
)	I	9
*	J	10
+	K	11
,	L	12
-	M	13
.	N	14
/	O	15
0	P	16
1	Q	17
2	R	18
3	S	19
4	T	20
5	U	21 ← Reserved for HP desktop computer address
6	V	22
7	W	23
8	X	24
9	Y	25
:	Z	26
;	[27
<	\	28
=]	29
>	^	30
?	-	LISTEN ONLY ← Reserved for universal unlisten command

2-15. HP-IB INTERFACE FUNCTIONS

The HP-IB interface offers 10 functions to support communications. Table 2-2 lists the HP-IB functions that the HP 16500A uses. A (-) indicates that the instrument does not implement that function.

Table 2-2. Model 16500A HP-IB Functions.

Mnemonic	Interface Function Name	HP 16500A Implementation
SH	Source Handshake	SH1
AH	Acceptor Handshake	AH1
T	Talker (or TE - Extended Talker)*	T5
L	Listener (or LE - Extended Listener)*	L4
SR	Service Request	SR1
RL	Remote Local	RL1
PP	Parallel Poll	PP1
DC	Device Clear	DC1
DT	Device Trigger	DT1
C	Any Controller	C0

2-16. RS-232-C INTERFACE

The HP Model 16500A interfaces with RS-232-C communications lines through a standard 25 pin D connector. The HP Model 16500A is compatible with RS-232-C protocol.

When a hardwire handshake method is used, the Data Terminal Ready (DTR) line (pin 20 on the Computer/Modem connector) is used to signal whether space is available in the logical I/O buffer for more data. Pin outs of the RS-232-C connectors are shown in Table 2-3.

Table 2-3. RS-232-C Signal Definitions

PIN NO.	FUNCTION	RS-232-C STANDARD	SIGNAL DIRECTION and LEVEL
1	Protective Ground	AA	Not applicable
2	Transmitted Data (TD)	BA	Data from Mainframe High = Space = "0" = +12V Low = Mark = "1" = -12V
3	Received Data (RD)	BB	Data to Mainframe High = Space = "0" = +3V to +25V Low = Mark = "1" = -3V to -25V
4	Request to Send (RTS)	CA	Signal from Mainframe High = ON = +12V Low = OFF = -12V
5	Clear to Send (CTS)	CB	Signal to Mainframe High = ON = +3V to +12V Low = OFF = -3V to -25V
6	Data Set Ready (DSR)	CC	Signal to Mainframe High = ON = +3V to +25V Low = OFF = -3V to -25V
7	Signal Ground (SGND)	AB	Not applicable
8	Data Carrier Detect (DCD)	CF	Signal to Mainframe High = ON = +3V to +25V Low = OFF = -3V to -25V
20	Data Terminal Ready (DTR)	CD	Signal from Mainframe High = ON = +12V Low = OFF = -12V
23	Data Signal Rate Selector	CH/CI	Signal from Mainframe Always High = ON = +12V

2-17. BAUD RATE SELECTION

The baud rate of the HP 16500A is set at power on for 9600 baud. To change the baud rate, perform the following instructions:

1. Cycle power or touch the upper left corner field of the touch screen. Touch the **System** field to obtain the System Configuration menu (see figure 2-8).

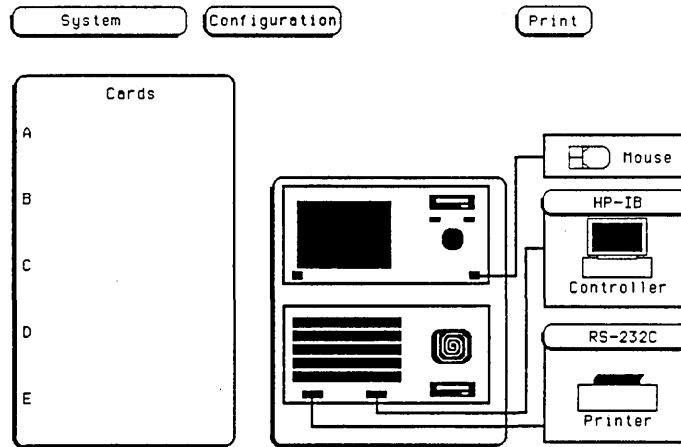

Figure 2-8. System Configuration with optional Mouse

2. Touch the **RS-232C** field in the lower right corner of the screen to call up the RS-232C configuration menu (see figure 2-9).

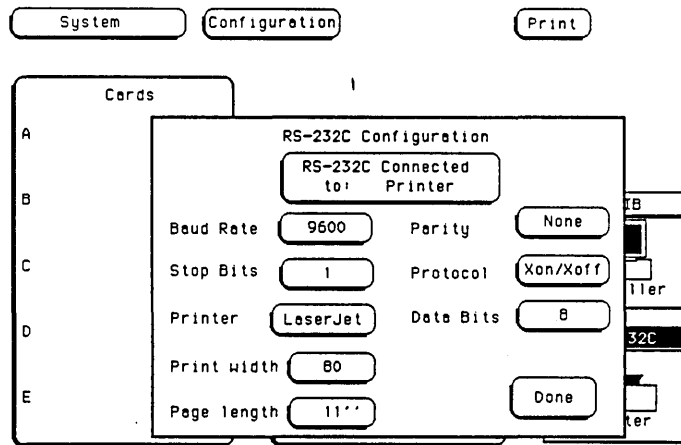

Figure 2-9. RS-232C Configuration Menu.

3. Touch the **Baud Rate** field and select the required rate (see figure 2-10). Make any other changes to the system configuration i.e. Parity, Printer Protocol etc. while you are in this menu.

4. When the RS-232C configuration is correct, touch the **Done** field and the System Configuration screen will be redisplayed.

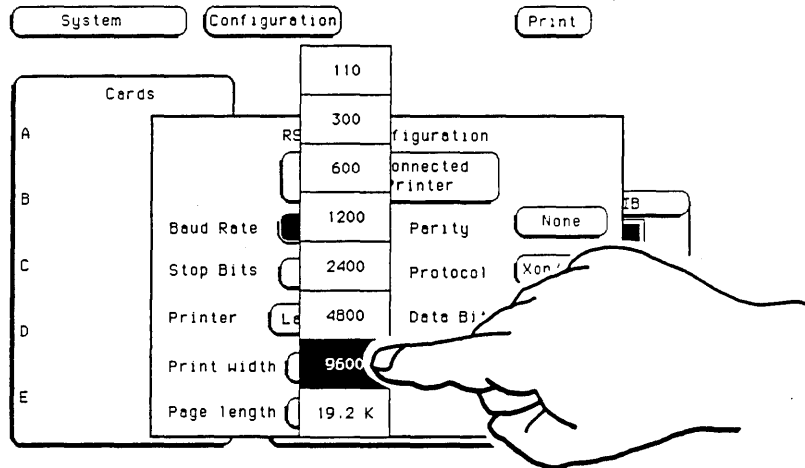

Figure 2-10. Baud Rate Pop-up Menu.

2-18. DEGAUSSING THE DISPLAY

After the instrument has been used for awhile, the CRT may become magnetized and color or other display data may become distorted. To correct, press the Degauss button on the power supply rear panel several times. If the instrument has been subjected to strong magnetic fields, it may be necessary to degauss the CRT with a conventional external television type degaussing coil.

2-19. OPERATING ENVIRONMENT

The operating environment is listed in table 1-2. Note should be made of the non-condensing humidity limitation. Condensation within the instrument can cause poor operation or malfunction. Protection should be provided against internal condensation.

The HP 16500A will operate at all specifications within the temperature and humidity range given in table 1-2. However, reliability is enhanced by operating the instrument within the following ranges.

Temperature: +20 to +35°C (+68 to +95°F)

Humidity: 20% to 80% non-condensing

2-20. STORAGE AND SHIPMENT

The instrument may be stored or shipped in environments within the following limits:

Temperature: -40°C to +75°C

Humidity: Up to 90% at 65°C

Altitude: Up to 15,300 metres (50,000 Feet)

The instrument should also be protected from temperature extremes which cause condensation within the instrument.

2-21. PACKAGING

The following general instructions should be used for repacking the instrument with commercially available materials.

- Remove Discs from disc drives and install the yellow shipping discs.
- Wrap instrument in heavy paper or plastic.
- Use a strong shipping container. A double-wall carton made of 350 lb. test material is adequate.
- Use a layer of shock-absorbing material 70 to 100 mm (3 to 4 inches) thick around all sides of the instrument to provide firm cushioning and prevent movement inside the container. Protect control panel with cardboard.
- Seal shipping container securely.
- Mark shipping container FRAGILE to ensure careful handling.
- In any correspondence, refer to instrument by model number and full serial number.

2-22. TAGGING FOR SERVICE

If the instrument is to be shipped to a Hewlett-Packard office for service or repair, attach a tag showing owner (with address), complete instrument serial number, and a description of the service required.

TABLE OF CONTENTS

PERFORMANCE TESTS

3-1. Introduction	3-1
-------------------------	-----

SECTION III PERFORMANCE TESTS

3-1. INTRODUCTION

This section normally contains the performance verification tests. Since there are no specifications for the mainframe to test, there are no performance tests.

TABLE OF CONTENTS

ADJUSTMENTS

4-1. Introduction	4-1
4-2. Degaussing the Display	4-1
4-3. Safety Considerations	4-1
4-4. Adjustment Test Patterns	4-2
4-5. Color Module Adjustments	4-7

SECTION IV ADJUSTMENTS

4-1. INTRODUCTION

The HP Model 16500A requires no adjusting when used in a normal environment. The procedure given in this section is for the color module. Do not perform these adjustments as part of regular maintenance. Observe the following rules before making any color module adjustments.

CAUTION

- *Do not perform this procedure as normal maintenance.*
- *Make adjustments only if the instrument has been subjected to extreme magnetic environments and the colors are incorrect.*
- *Before making any adjustments, try degaussing the unit using the rear panel degaussing switch or a color television type degaussing coil.*
- *Only qualified personnel who are familiar with color CRT convergence procedures should perform this adjustment.*
- *Before adjustments are made, mark the position where potentiometers are. This allows you to return the adjustments to their original starting position.*

4-2. DEGAUSSING THE DISPLAY

After the instrument has been used for awhile, the CRT may become magnetized and color or other data may become distorted. To correct, press the Degauss button on the power supply rear panel several times.

If the instrument has been subjected to strong magnetic fields, it may be necessary to degauss the CRT with a conventional television type degaussing coil.

4-3. SAFETY CONSIDERATIONS

Although this instrument has been designed in accordance with international safety standards, general safety precautions must be observed during all phases of operation, service, and repair of the instrument. Failure to comply with the precautions listed in the Safety Summary at the front of this manual, or with specific warnings given throughout this manual, could result in serious injury or death. Service adjustments should be performed only by qualified service personnel.

WARNING

Read the Safety Summary at the front of this manual before performing adjustment procedures. The apparatus shall be disconnected from all voltage sources before it is opened for any adjustment, replacement, maintenance, or repair.

4-4. ADJUSTMENT TEST PATTERNS

Six test patterns are required for adjusting the color module: the white cross hatch pattern, a white full screen raster, a full screen pattern for each primary color, and a black full screen raster.

Access to the test patterns is gained through the Mainframe Test system. To access the test patterns, perform the following steps:

1. Cycle power to obtain the System Configuration.

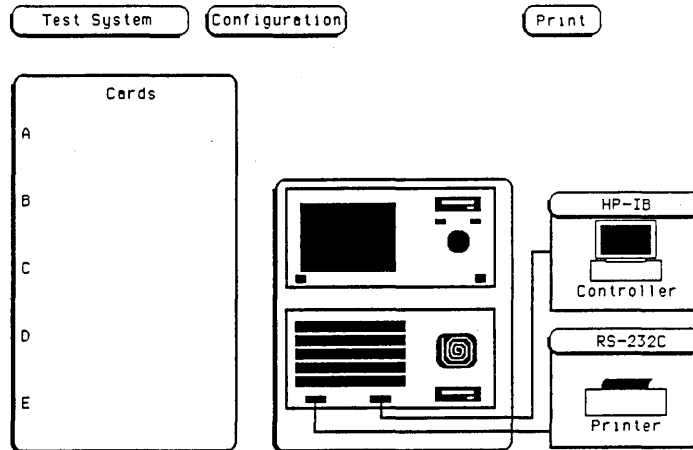

Figure 4-1. System Configuration Menu

2. Touch **Configuration** field and the **Test** field from the pop-up menu (see figure 4-2).

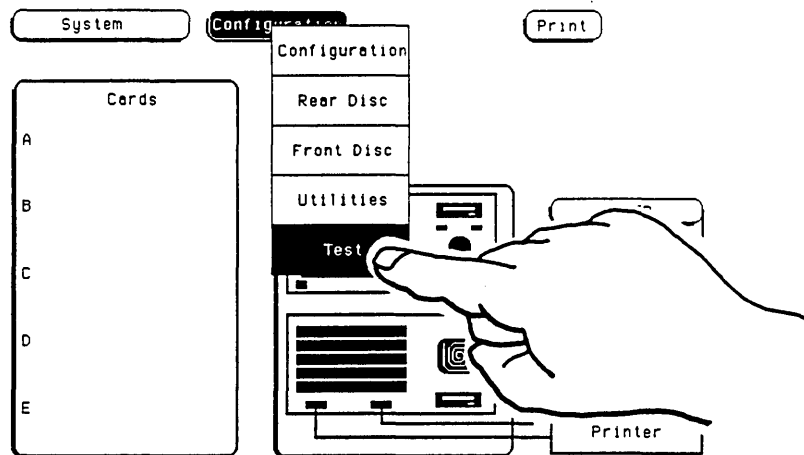

Figure 4-2. Accessing the Test System

3. Touch the field in the center of the screen to load the Test System (see figure 4-3).

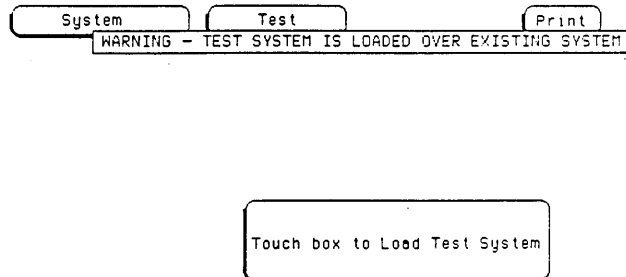

Figure 4-3. Loading the Test System.

4. After the Test System has been loaded from the disc, the Test Configuration will be displayed (see figure 4-4).

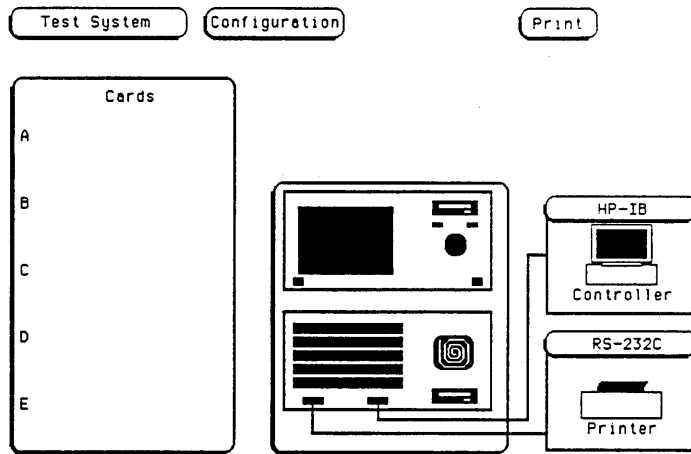

Figure 4-4. Test System Configuration

5. Touch the **Test System** field and select **Mainframe Test** from pop-up menu (see figure 4-5).

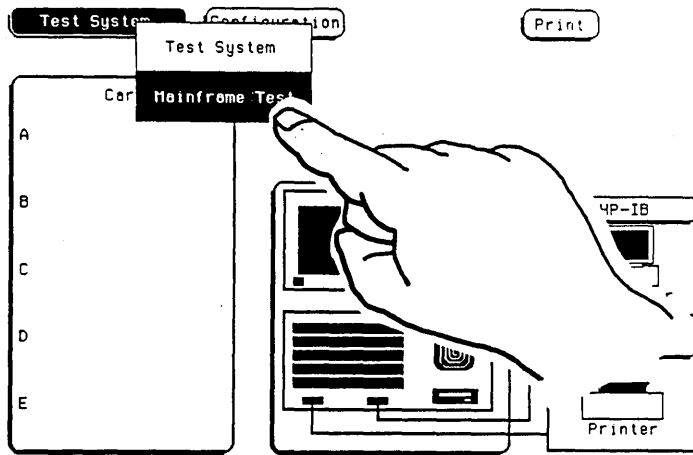

Figure 4-5. Selecting Mainframe Test menu

6. The Mainframe Test menu is now displayed (see figure 4-6). Select the **Color Display Test** field to call up the white cross hatch test pattern, the first test pattern in the system (see figure 4-7).

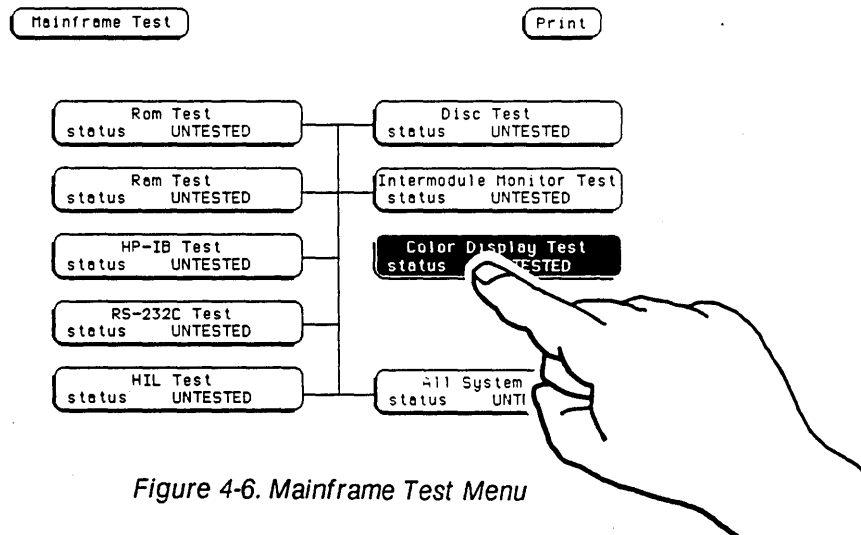

Figure 4-6. Mainframe Test Menu

- With every touch of the **Continue** field, the next test pattern will be displayed (see figure 4-7).

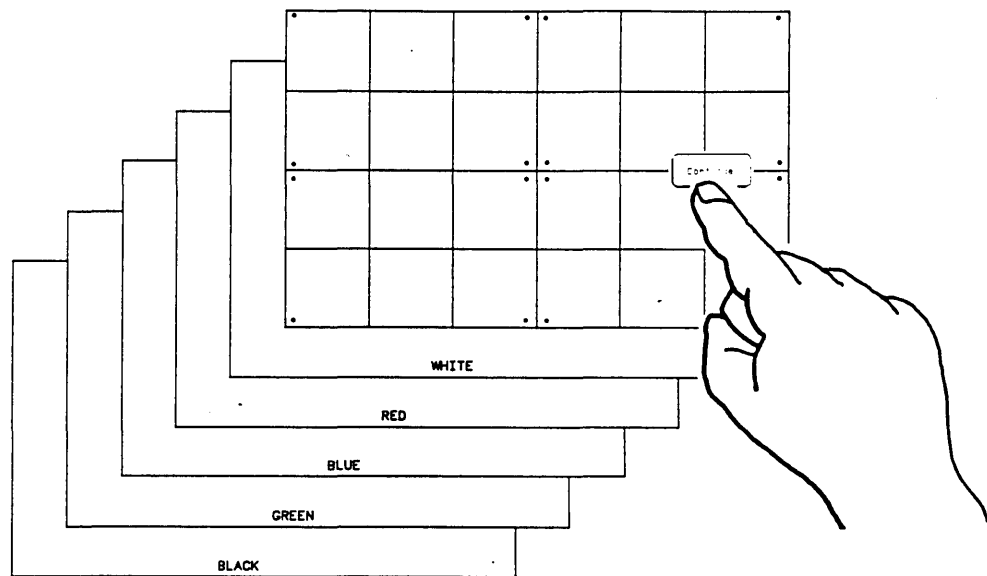

Figure 4-7. Selecting the Test Patterns

When **Continue** is selected from the black raster pattern, the Mainframe Test menu will be redisplayed. Notice that the status of the Display Test field has changed to TESTED.

- To exit the Mainframe Test system and to reload the mainframe operating system, touch the **Mainframe Test** field and the **Test System** field from the pop-up menu. The Test System configuration will be displayed (see figure 4-8).

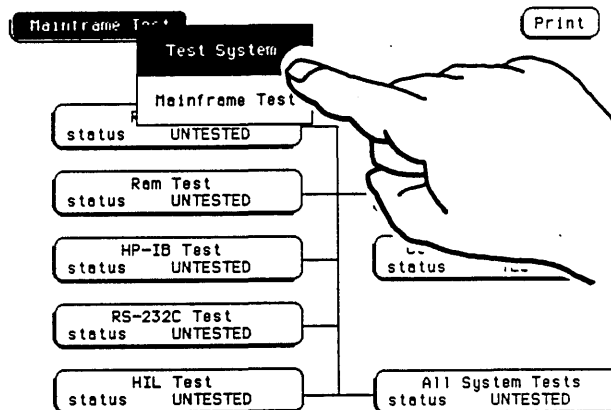

Figure 4-8. Exiting Mainframe Test System

9. Touch the **Configuration** field. Select **Exit Test** and touch the field in the center of the screen to reload the mainframe operating system (see figure 4-9).

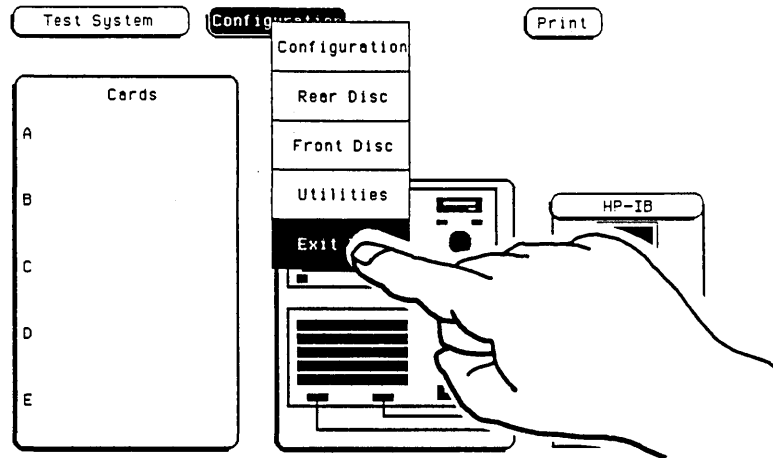

Figure 4-9. Exiting Test System

10. After the operating system has been reloaded, the System Configuration will be redisplayed (figure 4-10).

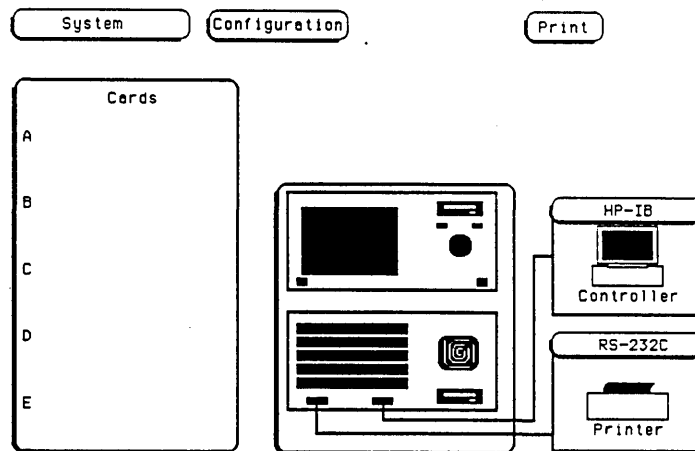

Figure 4-10. System Configuration

4-5. COLOR MODULE ADJUSTMENTS

Description:

The Color Module is adjusted to compensate for external magnetic influences causing mis-convergence.

NOTE

DO NOT continue with this procedure before first degaussing the CRT screen using the rear panel degaussing switch. In extreme cases of magnetism, it may be necessary to degause the CRT using a conventional external television-type degaussing coil. During any of the following adjustments, the CRT module must face west.

Equipment Required:

Non-metallic Adjustment Tool HP Part Number 8710-1355

Procedure:

NOTE

The following adjustments are broken down in adjustment groups. The Adjustment group sequence must be followed due to interaction and dependency. The adjustment group sequence is shown in the adjustment flow diagram in figure 4-1. There will be cases where not all the adjustment groups will be used. For example, if the Geometry Adjustment Group corrects the problem, this will be the only group used.

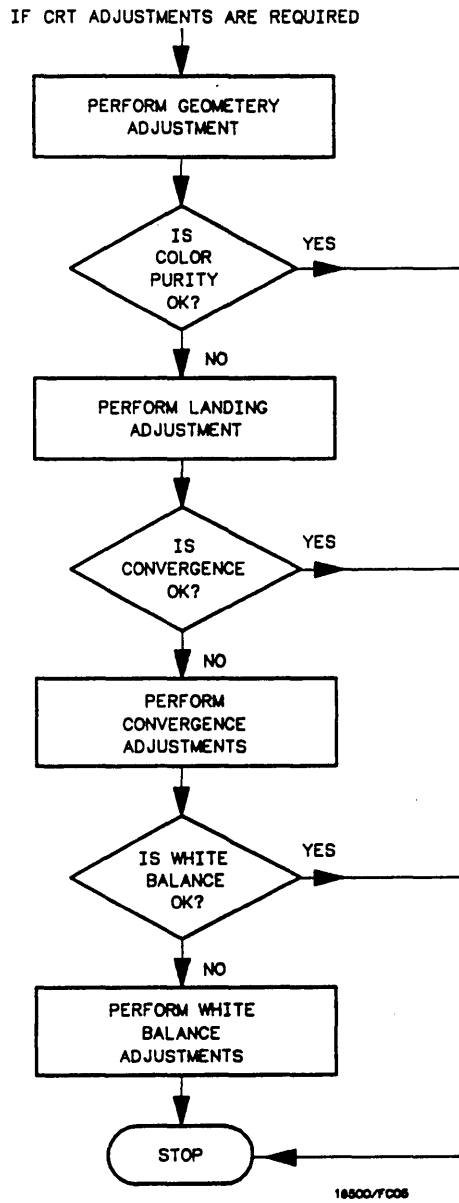

Figure 4-11. CRT Module Adjustment Flow Diagram.

Geometry Adjustments

1. From the Mainframe Test System, select the Display Test menu. Select the white cross hatch test pattern. Refer to paragraph 4-8 this section for accessing the test patterns.
2. Preset front panel BACKGROUND control to mechanical center.
3. Preset front panel BRIGHTNESS control to maximum.
4. Preset H.SUB SHIFT (RV006) and V.SUB SHIFT (RV008), located on bottom PC board, to mechanical center.
5. Using a flexible ruler, adjust H.SIZE (RV504) and V.HEIGHT (RV502), located on left hand side PC board, so cross-hatch pattern's border displayed on CRT is 120.5 mm (4.74 in.) vertically and 161 mm (6.34 in.) horizontally.
6. Adjust V.CENT (RV510) and H.CENT (RV503), located on left hand side PC board, to center pattern.
7. Adjust PIN AMP (RV506), located on left hand side PC board, to eliminate pincushion distortion in the vertical lines of the cross-hatch pattern as shown in figure 4-12.

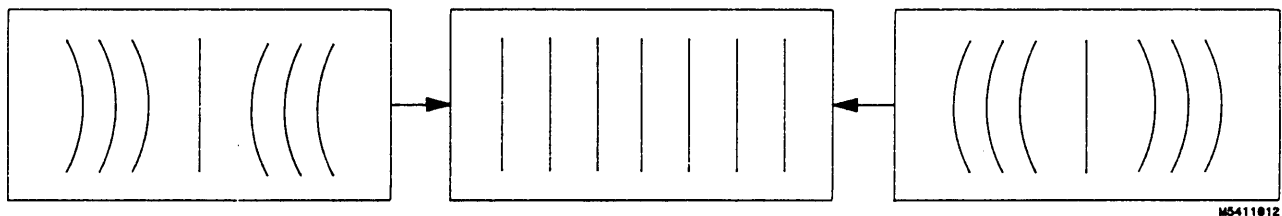

Figure 4-12. PIN AMP Adjustment.

Geometry Adjustments (Continued)

8. Set instrument on its left side, color module side up, and remove bottom rail (see figure 4-13).

NOTE

Leave instrument standing on its left side until the PIN PHASE adjustment has been completed.

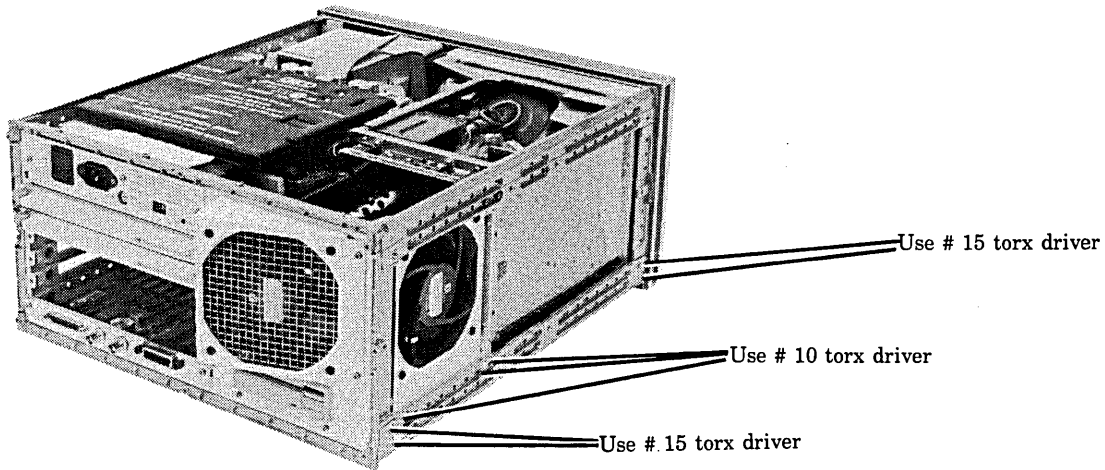
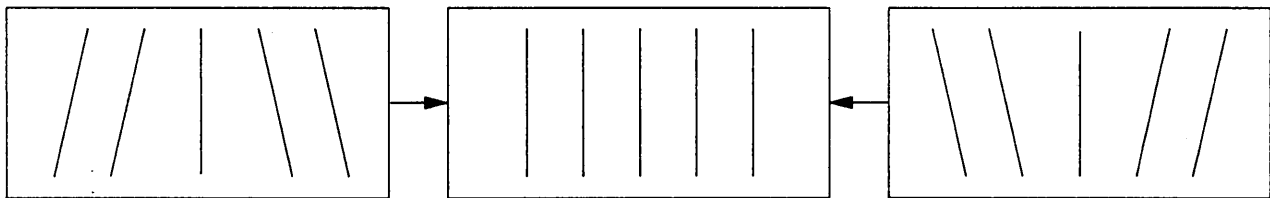

Figure 4-13. Bottom Rail Removal

9. Adjust PIN PHASE (RV505), located on left side PC board, to eliminate pin phase distortion in vertical lines of cross-hatch pattern as shown in figure 4-14.



16500/BL03

Figure 4-14. PIN PHASE Adjustment.

10. Reinstall bottom rail.
11. Adjust TOP PIN (RV511), located on left hand side PC board, so that top horizontal line is parallel with center horizontal line.
12. Adjust BOTTOM PIN (RV512), located on left hand side PC board, so that bottom horizontal line is parallel with center horizontal line.

Focus Adjustment:

NOTE

Geometry adjustments must be performed before making focus adjustment.

1. Remove rear and side fan. Refer to Section VI, paragraph 6-12 for removal procedure.
2. From the Display Test menu of the Mainframe Test system, select the white cross hatch test pattern.
3. Adjust FOCUS (RV701), located on rear PC board, for best overall focus.

Landing and Convergence Adjustment Preparation:

1. From the Display Test menu, select a white raster pattern and check for color purity. Repeat the procedure using the Red, Green and Blue raster patterns and check for color purity. If color purity is correct, do not perform the Landing adjustment.
2. Remove power from instrument and loosen deflection yoke clamp screw.
3. Remove deflection yoke spacers by moving deflection yoke rearward and removing spacers.

NOTE

The deflection yoke spacers are tapered rubber blocks located between front of yoke and rear of CRT funnel.

4. Apply power and allow instrument to thermally restabilize for 20 minutes.

WARNING

Exercise caution when moving purity magnets. Power is applied to the instrument and high voltages are present around the CRT.

Landing Adjustment:

1. From the Display Test menu, select the white raster (full screen display).
2. Turn front panel BRIGHTNESS Control to maximum.
3. Degauss entire CRT screen by pressing DEGAUSSING switch located on instrument's rear panel.

NOTE

In cases where the user's environment or shipping environment has caused high levels of magnetization to take place, it may be necessary to externally degauss the CRT using a conventional television-type degaussing coil to completely degauss the CRT.

4. Set purity magnet tabs to mechanical center (see figure 4-15).

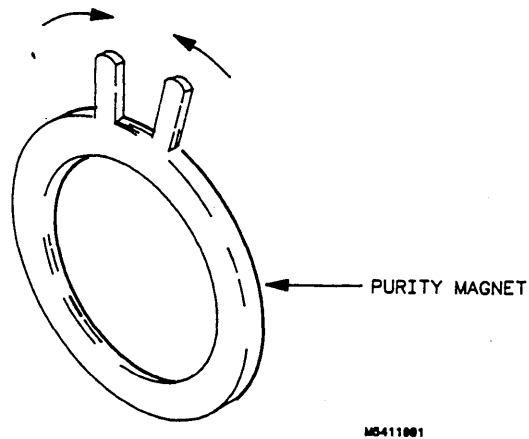

Figure 4-15. Purity Magnet Centering.

5. Select the green raster from the Display Test menu.

Landing Adjustment: (Continued)

6. Move deflection yoke rearward until left edge of raster turns red and right side of raster turns blue (see figure 4-16).

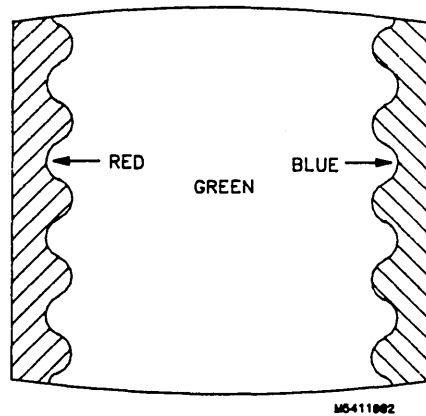

Figure 4-16. Purity Magnet Adjustment Raster.

7. Adjust purity magnets until green is in center of raster with red and blue bands evenly distributed on sides (see figure 4-15). The purity magnets need no more than $\pm 15^\circ$ movement from mechanical center.
8. Move deflection yoke forward until entire raster is green.

NOTE

Landing adjustment is easier if yoke is moved all the way forward and then moved rearward until raster is completely green.

9. Replace the green raster with a full screen red raster. Check for proper landing adjustment (color purity). Select a blue full screen raster and check it for proper landing adjustment.

Landing Adjustment: (Continued)

10. If landing is not correct in step 9, repeat steps 6 through 9 for best compromise (see figure 4-17).

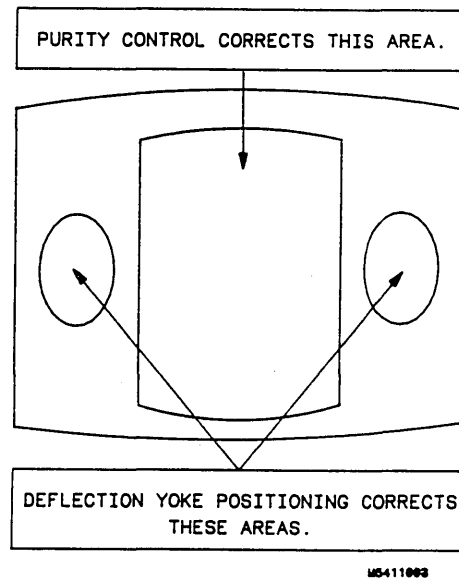

Figure 4-17. Landing and Purity Adjustment Guide.

11. If landing is not correct in step 10, readjust purity magnets for best landing of each color.
12. Remove power from instrument and reinstall the yoke spacers.
13. When landing adjustment is complete, tighten deflection yoke clamp screw just enough to keep yoke from moving. **DO NOT over-tighten.**

NOTE

While moving deflection yoke forward and rearward, rotate yoke as necessary to make vertical edges of raster parallel to the sides of the instrument frame.

Static Convergence:

1. Preset front panel BACKGROUND control to mechanical center.
2. Preset front panel BRIGHTNESS control to maximum.
3. Temporarily disconnect power from instrument and remove PC board shield cover from rear of CRT Display Module by prying evenly on all four sides.
4. Re-apply power and from the Display Test menu select the white cross hatch test pattern.
5. Check four dots which are located around center intersection of cross-hatch pattern for coincidence of blue, red, and green dots. If the dots are not coincident, adjust H.STAT (RV703), located on rear PC board, to obtain horizontal coincidence and V.STAT (RV803), located on bottom PC board, to obtain vertical coincidence (see figure 4-18).

NOTE

Due to interaction, BEAM LANDING will need to be re-adjusted if either H.STAT or V.STAT adjustments are made. Once BEAM LANDING is re-adjusted, repeat step 5 above if necessary to obtain center screen coincidence of the dots.

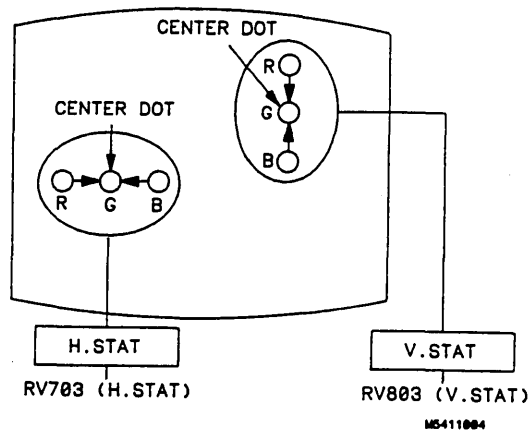

Figure 4-18. Static Convergence.

Dynamic Convergence:

1. From the Display Test menu, select the white cross hatch test pattern.
2. Adjust Y BOW (RV805), located on bottom PC board, to eliminate red, green, and blue bowing at top and bottom of center vertical line (see figure 4-19).

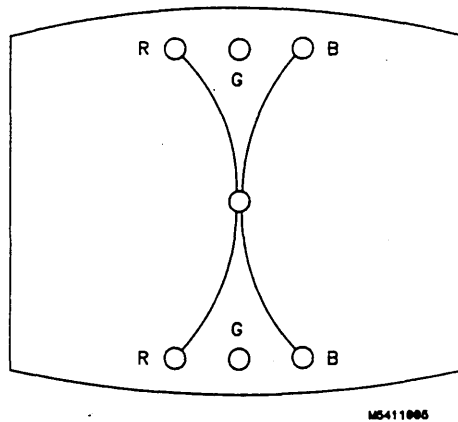

Figure 4-19. Y BOW Adjustment.

3. Adjust Y BOW CROSS (RV804), located on bottom of PC board, to eliminate red, green, and blue orthogonal mis-alignment at top and bottom of center vertical line (see figure 4-20).

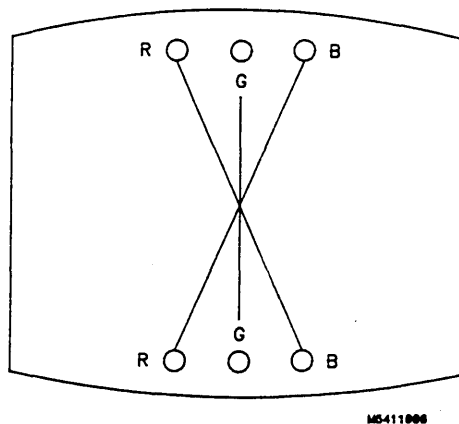

Figure 4-20. Y BOW CROSS Adjustment.

Dynamic Convergence: (Continued)

4. Adjust V.STAT TOP (RV801) and V.STAT BOTTOM (RV802), located on bottom PC board, to obtain coincidence of red, blue, and green at intersection of top and bottom horizontal lines with center vertical line (see figures 4-21 and 4-22).

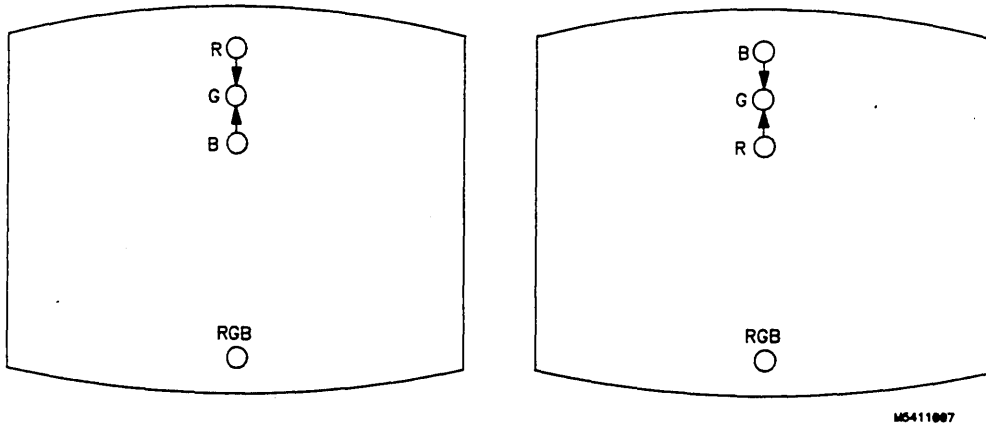

Figure 4-21. V.STAT TOP Adjustment.

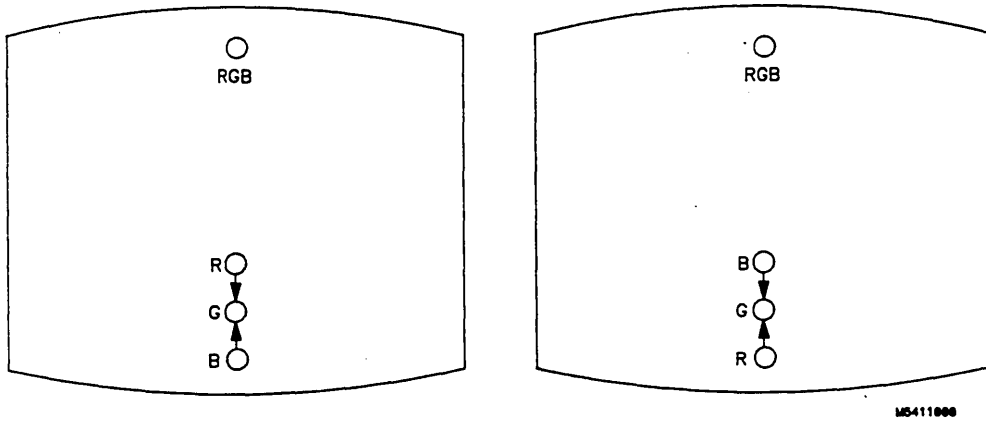

Figure 4-22. V.STAT BOTTOM Adjustment.

Dynamic Convergence: (Continued)

- Adjust H.AMP (RV807), located on bottom PC board, for equal amounts of mis-convergence at right and left sides of screen (see figure 4-23).

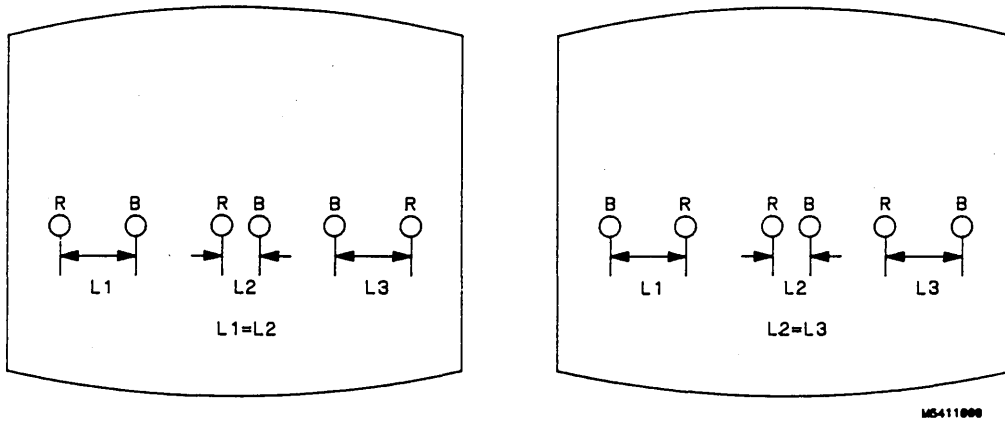

Figure 4-23. H.AMP Adjustment.

- Adjust H.TILT (RV806), located on bottom PC board, for coincidence of red, green, and blue at right and left sides of screen (see figure 4-24).

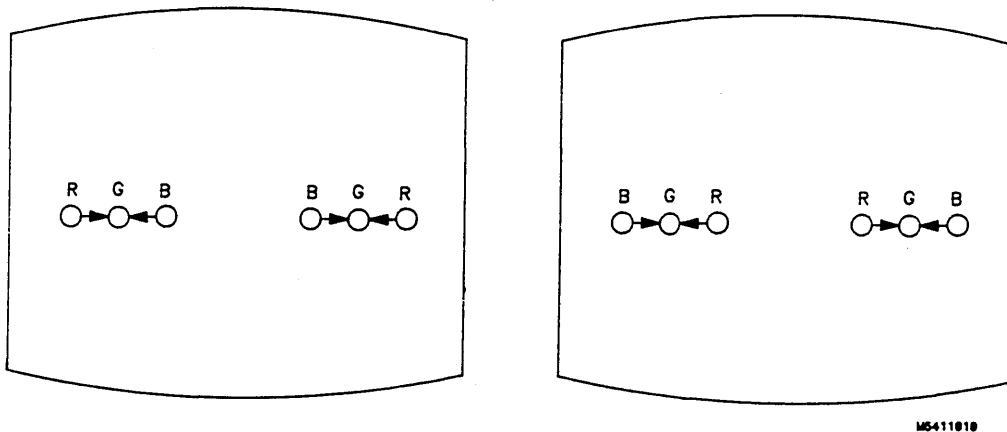

Figure 4-24. H.TILT Adjustment.

White Balance:

1. From the Display Test menu, select a blank (colorless) raster.

NOTE

Any text on screen will not affect this adjustment.

2. Set front panel BACKGROUND and SUB BRT (RV901), located on bottom PC board, to mechanical center.
3. Set front panel BRIGHTNESS and SUB CONT (RV902), located on bottom PC board, to mechanical center.
4. Set G. DRIVE (RV921), B. DRIVE (RV931), and R. DRIVE (RV911), located on bottom PC board, to mechanical center.
5. Set G.BKG (RV721), B.BKG (RV731), and R.BKG (RV711), located on rear PC board, fully counterclockwise (CCW).
6. Adjust SCREEN (RV702), located on rear PC board, until either a red, green, or blue raster just starts to become visible. Note which color becomes visible first and do not adjust background control (BKG) for that color in the next step.
7. Adjust other two background (BKG) controls for best white balance.
8. From the Display Test menu, select the white raster test pattern.
9. Set front panel BRIGHTNESS control to maximum.
10. Observe screen and adjust DRIVE controls (RV921, RV931, and RV911), located on bottom PC board, for best white balance.

NOTE

Using an average piece of white photocopy paper, compare the white on the CRT to the paper.

11. Repeat steps 1-3 and 6-10 until satisfied with white balance.
12. Reinstall cooling fans. Refer to Section VI paragraph 6-12 for installation procedure.

TABLE OF CONTENTS

REPLACEABLE PARTS

5-1. Introduction	5-1
5-2. Abbreviations	5-1
5-3. Replaceable Parts List	5-1
5-4. Exchange Assemblies	5-1
5-5. Ordering Information	5-1
5-6. Direct Mail Order System	5-2

SECTION V

REPLACEABLE PARTS

5-1. INTRODUCTION

This section contains information for ordering parts. Table 5-1 lists abbreviations used in the parts list, table 5-2 lists all replaceable parts in reference designator order.

5-2. ABBREVIATIONS

Table 5-1 lists abbreviations used in the parts list and throughout the manual. In some cases, two forms of the abbreviations are used, one all in capital letters, and one partial or no capitals. This occurs because the abbreviations in the parts list are always all capitals. However, in other parts of the manual other abbreviation forms are used with both lower and uppercase letters.

5-3. REPLACEABLE PARTS LIST

Table 5-2 is the list of replaceable parts and is organized as follows:

- a. Electrical assemblies in alphanumerical order by reference designation.
- b. Chassis-mounted parts in alphanumerical order by reference designation.
- c. Electrical assemblies and their components in alphanumerical order by reference designation.

The information given for each part consists of the following:

- a. Complete reference designation.
- b. Hewlett-Packard part number.
- c. Total quantity (Qty) in instrument.
- d. Check digit (for HP use only).

- e. Description of part.
- f. The manufacturers' code.
- g. The manufacturers' part number.

The total quantity for each part is only given once - at the first appearance of the part number in the list.

5-4. EXCHANGE ASSEMBLIES.

Some of the parts used in this instrument have been set up on a Blue-stripe board exchange program. This allows the customer to exchange his faulty assembly with one that has been repaired, calibrated, and performance verified at the factory. The cost of the exchange assembly is significantly less than that of a new part.

Exchangeable parts are listed separately in the mainframe parts list, table 5-2. They have a part number in the form XXXXX-695XX (where the new part would be XXXXX-665XX).

Before ordering a Blue-stripe assembly, check with your local HP parts or repair organization for the procedures associated with the Blue-stripe program.

5-5. ORDERING INFORMATION

To order a part listed in the replaceable parts table, quote the Hewlett-Packard part number, check digit, indicate the quantity required, and address the order to the nearest Hewlett-Packard office.

To order a part that is not listed in the replaceable parts table, include the instrument model number, instrument serial number, the description and function of the part, and quantity of parts required. Address the order to the nearest Hewlett-Packard office.

5-6. DIRECT MAIL ORDER SYSTEM

Within the USA, Hewlett-Packard can supply parts through a direct mail order system. Advantages of using the system are as follows:

- a. Direct ordering and shipment from Hewlett-Packard Parts Center in Mountain View, California.
- b. No maximum or minimum on any mail order (there is a minimum order amount for parts ordered through lo-

cal Hewlett-Packard offices when orders require billing and invoicing).

- c. Prepaid transportation (there is a small handling charge for each order).
- d. No invoices - to provide these advantages, check or money order must accompany each order.

Mail order forms and specific ordering information are available through your local Hewlett-Packard offices.

HP 16500A - Replaceable Parts

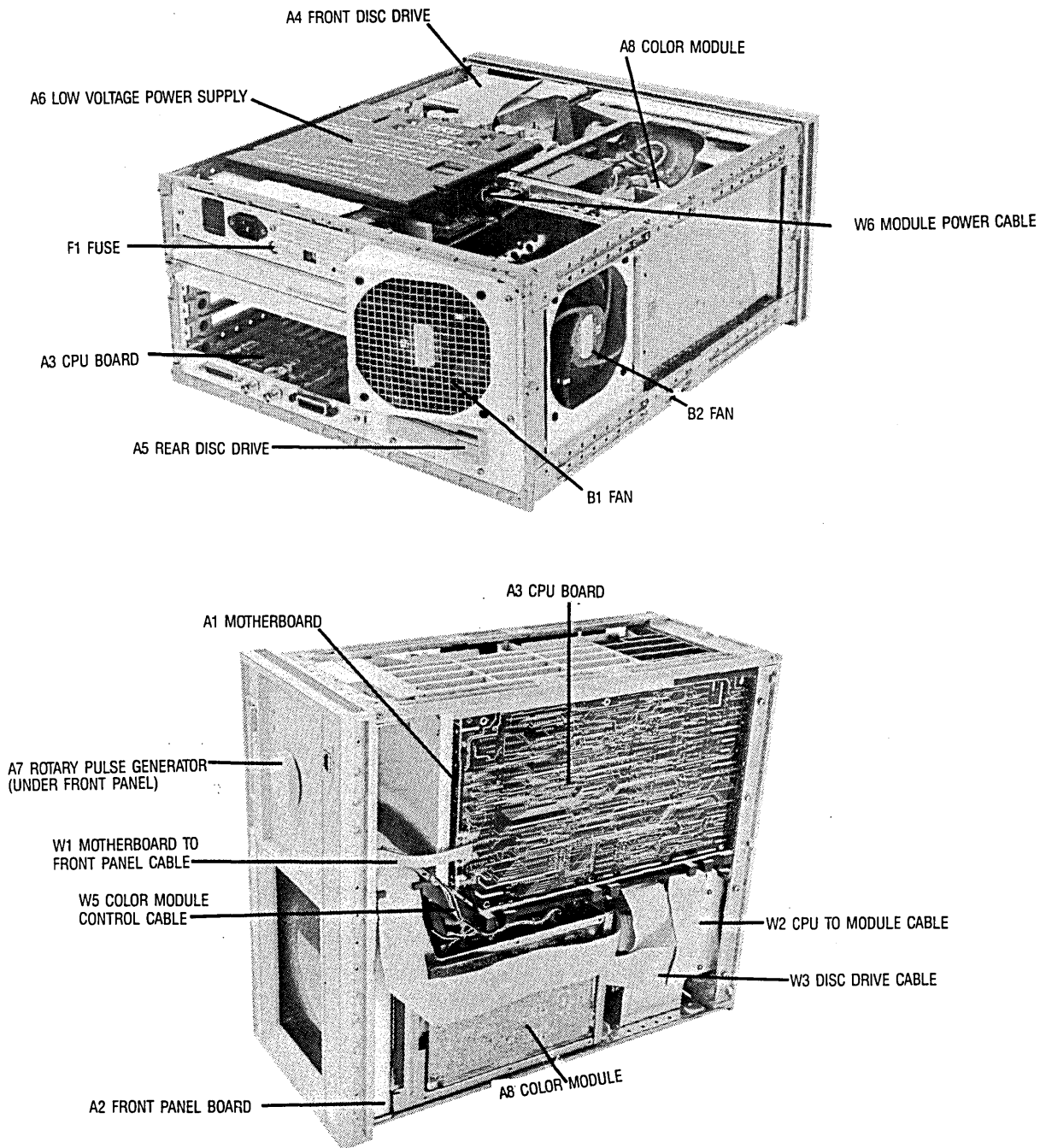

Figure 5-1. Electrical Assembly Identification

Table 5-2. Replaceable Parts

Reference Designation	HP Part Number	CD	Qty.	Description	Mfr Code	Mfr Part Number
A1	16500-66501	8	1	BD ASSY - MOTHER	28480	16500-66501
A2	16500-66502	9	1	BD ASSY - FRONT PANEL	28480	16500-66502
A2	16500-69502	5	1	BD ASSY - FRONT PANEL	28480	16500-69502
A3	16500-66503	0	1	BD ASSY - CPU	28480	16500-66503
A3	16500-69503	6	1	BD ASSEMBLY CPU, REBUILT	28480	16500-69503
A4	0950-1798	0	2	FRONT DISC DRIVE	28480	0950-1798
A5	0950-1798	0		REAR DISC DRIVE	28480	0950-1798
A6	0950-1853	8	1	ASSY - LOW VOLTAGE POWER SUPPLY	28480	0950-1853
A7	0960-0753	6	1	ASSY - ROTARY PULSE GENERATOR	28480	0960-0753
A8	2090-0092	3	1	ASSY COLOR CRT MODULE	28480	2090-0092
B1	3160-0377	7	2	FAN-TBAX 122-CFM 9.5-14VDC	28480	3160-0377
B2	3160-0377	7		FAN-TBAX 122-CFM 9.5-14VDC	28480	3160-0377
F1	2110-0010	9	1	FUSE - 5 AMP FOR 230VAC OPERATION	28480	2110-0010
F1	2110-0395	0	1	FUSE-10AMP - FOR 115VAC OPERATION	28480	2110-0395
W1	16500-61601	9	1	CABLE ASSY - MOTHER BOARD TO FRONT PANEL	28480	16500-61601
W2	16500-61602	0	1	CABLE ASSY - CPU TO COLOR MODULE	28480	16500-61602
W3	16500-61603	1	1	CABLE ASSY - CPU TO DISC	28480	16500-61603
W4	16500-61604	1	1	CABLE ASSY - FAN POWER	28480	16500-61604
W5	16500-61605	3	1	CABLE ASSY - COLOR MODULE CONTROL	28480	16500-61605
W6	16500-61606	4	1	CABLE ASSY - COLOR MODULE POWER	28480	16500-61606
W7	8120-1521	6	1	POWER CORD - UNITED STATES	28480	8120-1521

HP 16500A - Replaceable Parts

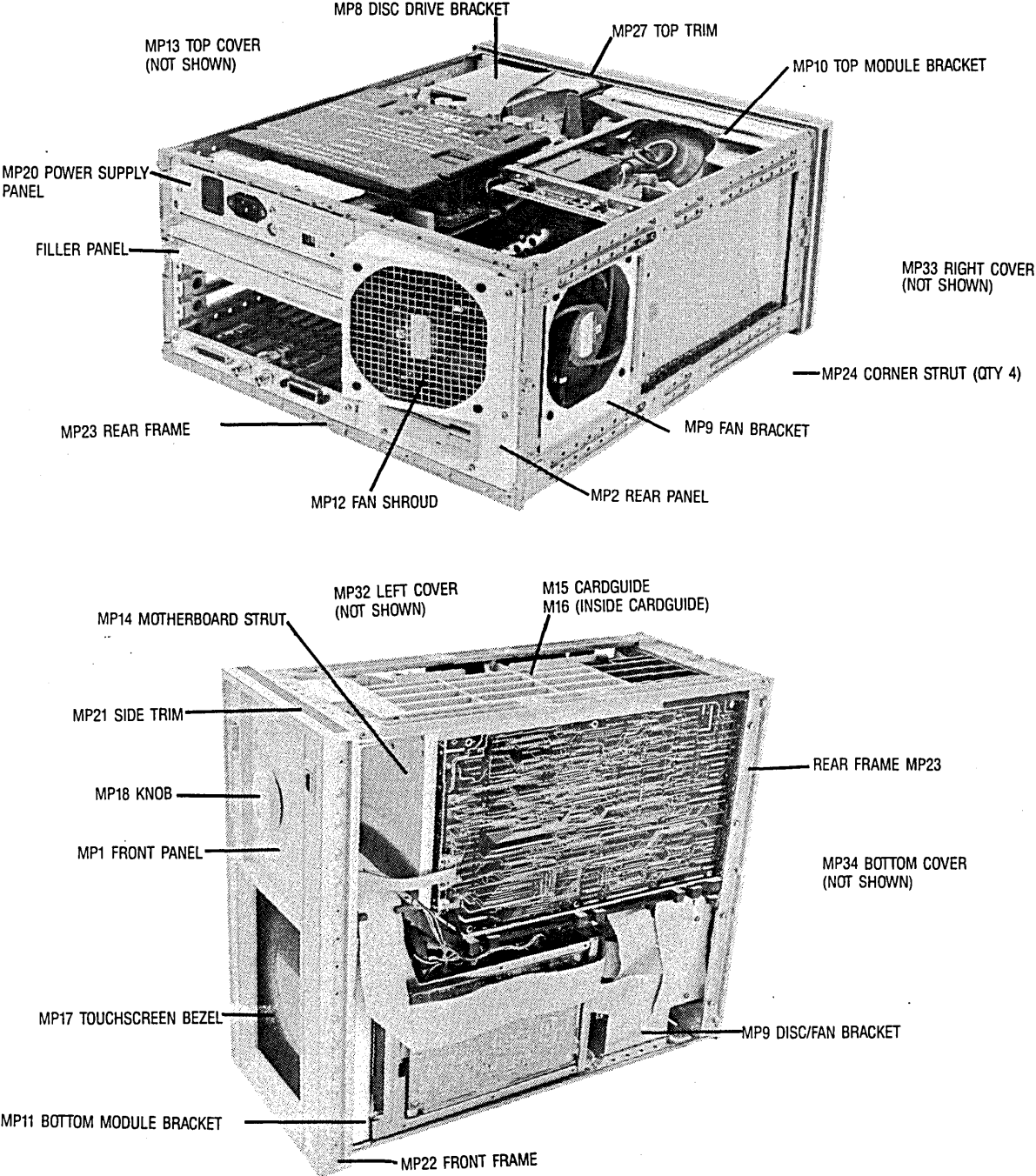

Figure 5-2. Chassis Parts Identification

Table 5-2. Replaceable Parts (continued)

Reference Designation	HP Part Number	CD	Qty.	Description	Mfr Code	Mfr Part Number
H1	0515-0372	2	36	SCREW-MACHINE ASSEMBLY M3 X 0.5 8MM-LG	28480	0515-0372
H2	0515-0380	2	12	SCREW-MACHINE ASSEMBLY M4 X 0.7 10MM-LG	28480	0515-0380
H3	0515-0435	8	4	SCREW-MACHINE ASSEMBLY M4 X 0.7 14MM-LG	28480	0515-0435
H4	0515-0664	5	4	SCREW-MACHINE ASSEMBLY M3 X 0.5 12MM-LG	28480	0515-0664
H5	0515-0943	3	14	SCREW-MACH M4 X 0.7 12MM-LG	28480	0515-0943
H6	0515-1384	8	2	SCREW-MACH M5 X 0.8 10MM-LG	28480	0515-1384
H7	0515-1403	2	16	SCREW-SPCL M4 X 0.7 6MM-LG 90-DEG-FLH-HD	28480	0515-1403
H8	0515-1444	1	4	SCREW-MACH M3.5 X 0.6 25.4MM-LG PAN-HD	28480	0515-1444
H9	0535-0105	1	4	NUT SHEET METAL M4	28480	0535-0105
H10	0535-0106	2	8	NUT SHEET METAL M4	28480	0535-0106
H11	0624-0520	3	9	SCREW-TPG 6-19 .5-IN-LG PAN-HD-TORX T15	28480	0624-0520
H12	0624-0644	2	8	SCREW-TPG 8-32 .5-IN-LG PAN-HD-TORX T15	93907	235-39581-732
H13	2190-0763	7	2	WASHER-FL MTLG NO. 6 .14-IN-ID .5-IN-OD	28480	2190-0763
H14	2950-0043	8	1	NUT-HEX-DBL-CHAM 3/8-32-THD .094-IN-THK	28480	2950-0043
H15	3050-0188	5	1	WASHER-SPR CRVD 3/8 IN .385-IN-ID	28480	3050-0188
H16	3050-1238	8	2	WASHER-FL NM 9/64 .149-IN-ID .478-IN-OD	86928	A-385-81-60
MP1	16500-40201	1	1	FRONT PANEL	28480	16500-40201
MP2	16500-00201	7	1	REAR PANEL	28480	16500-00201
MP3	0363-0125	0	4	RFI STRIP-FINGERS BE-CU BRIGHT DIP	28480	0363-0125
MP4	1460-1345	5	2	TILT STAND SST	28480	1460-1345
MP5	16500-00601	1	1	STATIC SHIELD	28480	16500-00601
MP6	16500-00602	2	1	DISC DRIVE SHIELD	28480	16500-00602
MP7	16500-00603	3	1	FAN SCREEN	28480	16500-00603
MP8	16500-01201	9	1	FRONT DISC DRIVE BRACKET	28480	16500-01201
MP9	16500-01202	0	1	REAR DISC DRIVE - FAN BRACKET	28480	16500-01202
MP10	16500-01205	3	1	TOP COLOR MODULE BRACKET	28480	16500-01205
MP11	16500-01206	4	1	BOTTOM COLOR MODULE BRACKET	28480	16500-01206
MP12	16500-01207	5	1	FAN SHROUD	28480	16500-01207
MP13	16500-04101	4	1	TOP COVER	28480	16500-04101
MP14	16500-04701	0	1	STRUT - MOTHERBOARD	28480	16500-04701
MP15	16500-23101	4	1	CARDGUIDE - LEFT SIDE	28480	16500-23101
MP16	16500-23102	5	1	CARDGUIDE - INSIDE	28480	16500-23102
MP17	16500-42201	5	1	TOUCHSCREEN BEZEL	28480	16500-42201
MP18	16500-42502	9	1	CONTROL KNOB	28480	16500-42502
MP19	16500-45401	3	1	INSULATOR - FRONT PANEL BOARD	28480	16500-45401
MP20	16500-61202	3	1	POWER SUPPLY COVER - REAR PANEL	28480	16500-61202
MP21	5001-0441	2	1	SIDE TRIM - FRONT	28480	5001-0441
MP22	5021-5807	6	1	FRAME - FRONT	28480	5021-5807
MP23	5021-5808	7	1	FRAME - REAR	28480	5021-5808
MP24	5021-5837	2	4	STRUT - CORNER	28480	5021-5837
MP25	5040-7201	8	2	FEET - FRONT	28480	5040-7201
MP26	54110-40502	3	4	FEET - REAR	28480	54110-40502
MP27	5040-7202	9	1	TOP TRIM STRIP	28480	5040-7202
MP28	5040-7222	3	2	FEET - REAR BOTTOM	28480	5040-7222
MP29	5041-6819	4	1	HANDLE CAP	28480	5041-6819
MP30	5041-6820	7	1	HANDLE CAP	28480	5041-6820
MP31	5060-9804	3	1	HANDLE	28480	5060-9804
MP32	5060-9947	5	1	LEFT SIDE COVER	28480	5060-9947
MP33	5061-9522	4	1	RIGHT SIDE COVER	28480	5061-9522
MP34	5061-9447	2	1	BOTTOM COVER	28480	5061-9447
MP35	54110-01210	8	1	COLOR MODULE BRACKET - REAR	28480	54110-01210
MP36	54110-04702	9	1	COLOR MODULE SUPPORT - REAR	28480	54110-04702
MP37	8160-0551	4	1	RFI ROUND STRIP STL MSH/SIL RBR SN-PL	28480	8160-0551
				MISCELLANEOUS		
	01650-84501	3		ACCESSORY POUCH		
	16500-40502	5		FILLER PANEL		

TABLE OF CONTENTS

SERVICE

6-1. Introduction	6-1
6-2. Safety Considerations	6-1
6-3. Service Test Equipment Required	6-1
6-4. Theory of Operation	6-1
6-5. System Overview	6-3
6-6. Microprocessor Board Theory	6-5
6-7. Power - Up Test	6-6
6-8. Mainframe Test System	6-7
6-9. Troubleshooting	6-16
6-10. Repair	6-29
6-11. Power Supply Replacement	6-30
6-12. Microprocessor Board Replacement	6-33
6-13. Mother Board Replacement	6-35
6-14. Front Panel Board Replacement	6-37
6-15. Display Module Replacement	6-39
6-16. Front Disc Drive Replacement	6-44
6-17. Rear Disc Drive Replacement	6-45
6-18. Cooling Fan Replacement	6-46

SECTION VI SERVICE

6-1. INTRODUCTION

This section provides troubleshooting information to the assembly level, assembly removal and replacement instructions, and block diagram level theory of operation.

6-2. SAFETY CONSIDERATIONS

The HP Model 16500A has been designed in accordance with accepted safety standards. Safety symbols used with Hewlett-Packard instruments are illustrated in the front matter of this manual. These symbols should be reviewed before service work is performed. Service work should be performed only by qualified service personnel.

6-3. SERVICE TEST EQUIPMENT REQUIRED

Equipment required for service is listed in Section I, Table 1-2. Any equipment that satisfies critical specifications given in the table may be substituted.

6-4. THEORY OF OPERATION

The following paragraphs contain block diagram level theory of operation for the HP 16500A Mainframe.

This level of theory is not intended for component level troubleshooting, rather it is to be used to help isolate an instrument failure to a replaceable assembly.

For component level troubleshooting, the Service Data Supplement for the HP 16500A is required.

The supplement contains schematics, component level theory of operation, component locators and a parts list for the microprocessor, front panel, and the mother boards. Schematics for the power supply and the color module are not included in the supplement. These assemblies are not field repairable and must be returned to the factory.

The theory of operation is divided into two parts: the System Overview and the Microprocessor Theory.

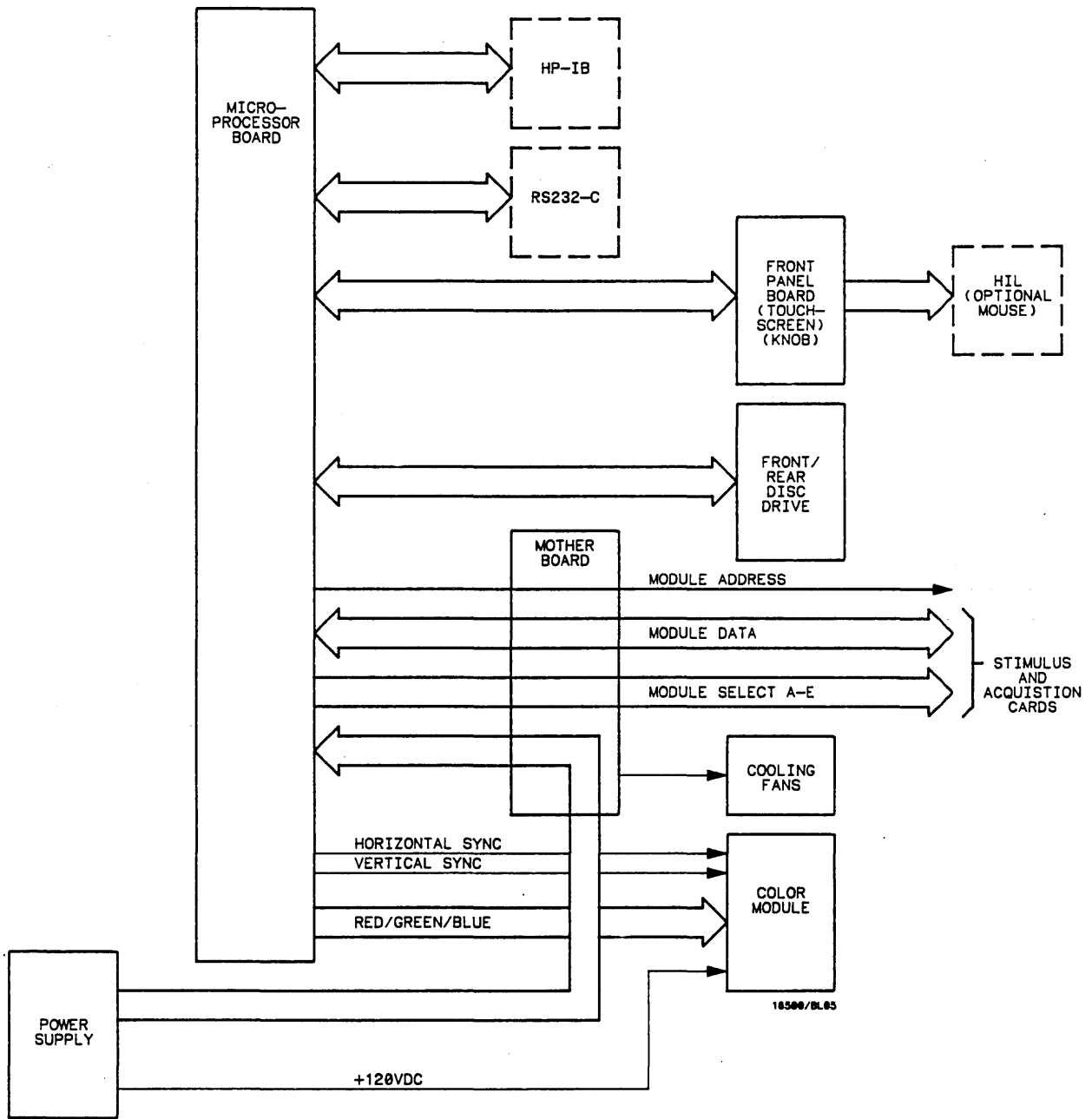

Figure 6-1. HP 16500A System Overview

6-5. System Overview

The HP 16500A is the mainframe for the Logic Analysis System and contains all the necessary components for interfacing with the optional acquisition and stimulus boards. The mainframe components are:

- Microprocessor Board
- Motherboard
- Front and Rear Disc Drives
- Color Module
- Front Panel Board
- Power Supply

The microprocessor board contains all the interface circuitry for managing dataflow between the mainframe components and the optional boards. The processor used is a Motorola 68000. ©

Located on the motherboard is the inter-module bus and the fan speed control circuit. The motherboard consists of seven card slots: five are used for the optional acquisition and stimulus boards, one for the microprocessor board and one for the power supply. The only active components on the motherboard are for the fan speed control circuit. The heat sensing thermistor for the fan speed control circuit is located on the microprocessor board.

The front and rear disc drives use 3.5 inch, double sided, double density discs. All the disc drive control circuitry is located on the microprocessor board.

The display is an eight plane color system. Each plane has a resolution of 576 pixels by 368 lines. The display is non-interlacing and is refreshed every 1/60 of a second (not synchronized to the AC line). The horizontal and vertical sync signals are generated by the CRT controller located on the microprocessor board. Color information for the display is generated on the microprocessor board. The display RAM and the color palette are also located on the microprocessor board.

The front panel board is based on the Hewlett-Packard Human Interface Link (HP-HIL) and consists of the touchscreen system, the front panel control knob and the optional mouse. All of the touchscreen and knob circuitry of the HP-HIL is located on the front panel board and the controller for the link is located on the microprocessor board.

The power supply provides the following regulated voltages:

- +120 Vdc
- +12.0 Vdc
- +5.0 Vdc
- +3.5 Vdc
- 3.25 Vdc
- 5.2 Vdc
- 12.0 Vdc

The +120.0 V supply is used only by the color module. Current limiting, overvoltage protection and thermal shutdown are provided for all supplies.

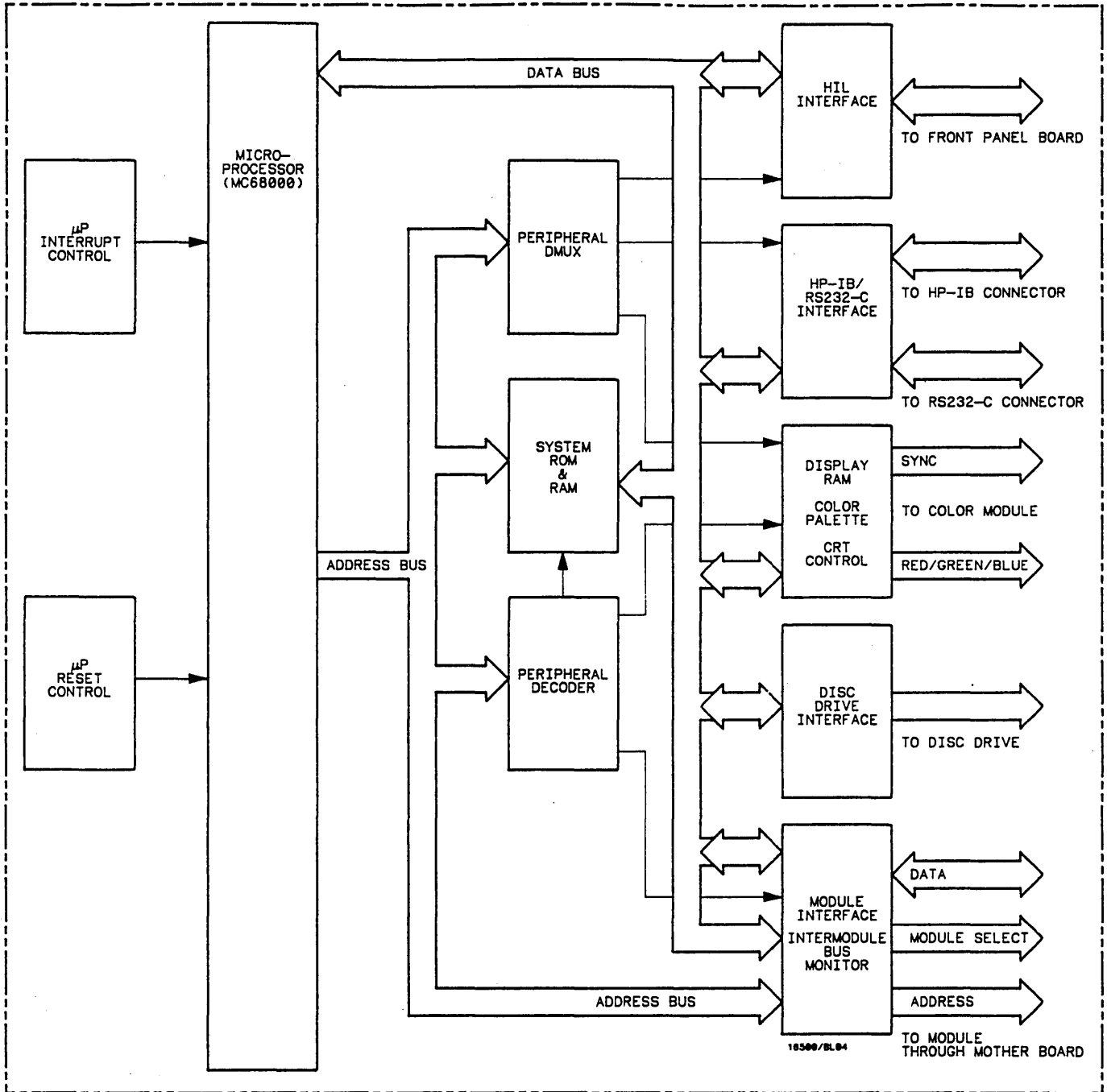

Figure 6-2. Microprocessor Block Diagram

6-6. Microprocessor Board Theory

The microprocessor board contains the system memory, all the interfaces for the mainframe peripherals, the intermodule bus monitor and the optional board module interface.

The mainframe peripheral interfaces are selected by the processor through the peripheral demultiplexer and peripheral decoder.

Using the three least significant processor address bits, the peripheral decoder selects system ROM and RAM, the display RAM and the module interface.

The peripheral demultiplexers select the HIL interface, HP-IB/RS-232-C interfaces, color palette and the disc drive interface.

System memory consists of 64K bytes of ROM and 512K words of RAM. Stored in ROM is part of the operating system, the power up selftests, the disc drive instructions and the Human Interface Link (HIL) driver.

The Hewlett-Packard Human Interface Link (HP-HIL) is the interface between the microprocessor and the front panel board. In the write mode, the interface controller serializes the the eight bit data and transmits it to the devices on the link. In the read mode, the data is fed to the interface controller in serial format and to the microprocessor in parallel format.

The display RAM consists of eight 64K by 4 RAMs and one four bit shift register for each RAM. Each RAM and shift register pair represents one color plane in the display system. The output of the color palette is an analog voltage of 0 V to -1.0 V for each of the primary colors (Red, Blue, Green) and is fed to the color module.

The HP 16500A interfaces to HP-IB as defined by IEEE Standard 488.2. The interface consists of two octal transceivers and an HP-IB controller.

The controller relieves the microprocessor of the task of maintaining HP-IB protocol. The two transceivers provide data and control signal transfer between the bus and the controller.

The HP 16500A mainframe RS-232-C interface is compatible with standard RS-232-C protocol. The interface consists of a controller, an input and an output buffer.

The controller serializes parallel data from the microprocessor for transmission. In the receive mode, the controller converts incoming serial data to parallel data for the processor. The controller also generates all the different baud rates and formats available with the mainframe. The input and output buffers transfer data and control signals to and from the RS-232-C communication lines.

The main components of the disc drive interface are the drive controller and the digital separator. The controller provides the interface between the microprocessor and the two disc drives. It also performs all functions necessary to write or read data to and from the discs. Data between the microprocessor and disc drives are serialized by the drive controller. The function of the digital separator is to synchronize data between the interface and disc drives.

The module interface provides microprocessor access to the acquisition and stimulus boards that are plugged into the mainframe.

The intermodule bus monitor provides the means for time-aligning module trace data on screen. This function is performed by a 100 MHz acquisition device, operating in the transitional timing mode.

6-7. POWER UP TEST

The HP 16500A power up tests check the mainframe circuitry only. None of the option modules are tested at power up. The tests run every time power is applied to the instrument.

If a disc is not installed into a disc drive the advisory "no disc" is added to the Rear and Front Disc Tests.

If the operating disc is not installed, and the mainframe passes the power up tests, the message

SYSTEM DISC NOT FOUND

is displayed. To boot the system, install the system disc into either disc drive and cycle power.

The power up tests perform the following circuit checks:

ROM TEST

The ROM Test performs a checksum of both ROMs and compares that value to the stored value. The test response is passed, impaired or failed. If the message "impaired" is displayed, only one of the ROMs on the microprocessor board is defective. If the message "failed" is displayed, both ROMs are defective.

RAM TEST

The RAM Test performs an abbreviated read/write test at various memory locations. The test returns a pass/fail message.

INTERRUPT TEST

The Interrupt Test checks the microprocessor interrupts (interrupts 2 through 7). If any interrupts are active, the test fails.

DISPLAY TEST

The Display Test checks the display RAM and the CRT controller. During the RAM test, the entire address range is checked. The CRT controller ensures that a End-Of-Frame interrupt is generated. The test will report a fail message if either the display RAMs or the controller tests fail.

HIL TEST

The HIL TEST consists of three parts: the HIL controller test, the front panel and touchscreen tests.

Depending on the test results, the first two tests (controller and front panel tests) report a pass/fail message. The touchscreen test may return a pass/fail or an impaired message. The impaired message is displayed if four or less LED pairs of the touchscreen system are defective. The impaired message is also displayed if the touchscreen test fails (more than four defective LED pairs) and a mouse is connected to the front panel HIL connector. The instrument is still functional if the touchscreen fails and a mouse is used. To obtain true touchscreen test results, disconnect the mouse before performing the test.

FRONT/REAR DISC TEST

The Disc Tests consists of identifying the format of each disc. If the disc cannot be identified, the test is considered to have failed for that disc drive. If no disc can be detected, the message "no disc" is displayed instead of the usual pass/fail message.

6-8. MAINFRAME TEST SYSTEM

The Mainframe Test System allows the testing of portions of the microprocessor board including the system peripheral interfaces, the disc drives and the color module.

The test software for the mainframe and each optional module is included on each system disc.

It is recommended that the test system for each module and the mainframe be copied to a separate disc.

Also, whenever the test system is loaded into memory, the normal system is overwritten including all setups or aquired data for the optional modules. To preserve that information, store it onto a disc before beginning any selftests.

ACCESSING THE MAINFRAME TEST SYSTEM

Use the following procedures to access the Mainframe Test System:

- a. Cycle power to obtain System Configuration (see figure 6-3).

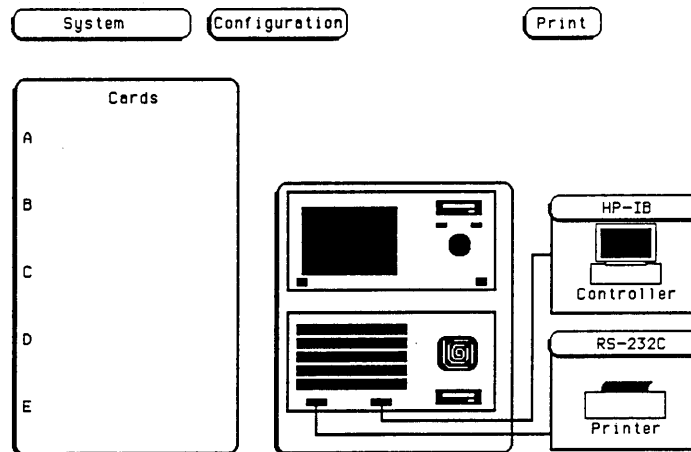

Figure 6-3. System Configuration

- b. Touch Configuration field and the Test field from the pop-up menu (see figure 6-4).

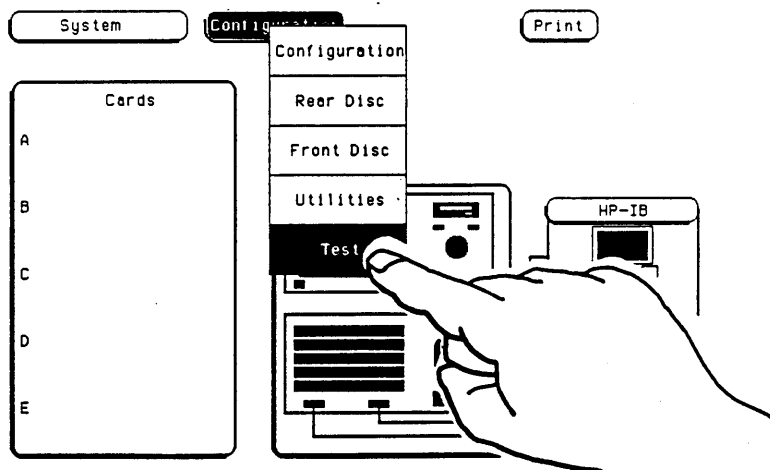
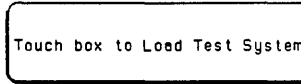
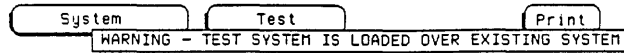

Figure 6-4. Accessing the Test System

c. Ensure that test files are on the installed disc and that all user data is copied onto a separate disc. Touch the field in the center of the screen to load the test system (see figure 6-5).



Card ID codes: SLOT A SLOT B SLOT C SLOT D SLOT E
 none none none none none

Figure 6-5. Loading the Test System Software

d. After the test software has been loaded, the Test System Configuration Menu will be displayed (figure 6-6).

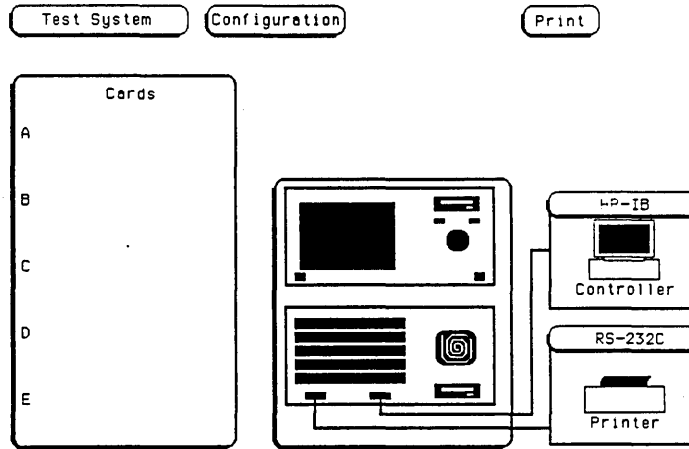

Figure 6-6. Test System Configuration

e. Touch the Test System field and select Mainframe Test from pop-up menu. The Mainframe Test menu will now be displayed (figure 6-7).

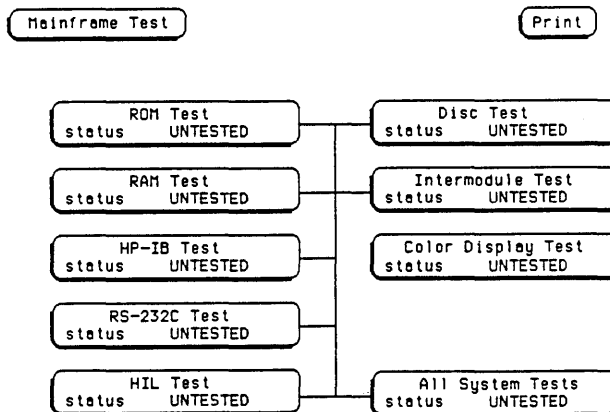

Figure 6-7. Mainframe Test Menu

PERFORMING THE ALL SYSTEM TEST

Perform the All System Test using the following procedure:

Before performing any mainframe tests, ensure that a formatted disc is installed in each disc drive. Ensure that discs are not write protected. Install the RS-232-C loopback connector on the micro-processor RS-232-C port.

With the Mainframe Test menu displayed, touch the All System Tests field. The instrument will perform all the tests that are listed on screen (see figure 6-8).

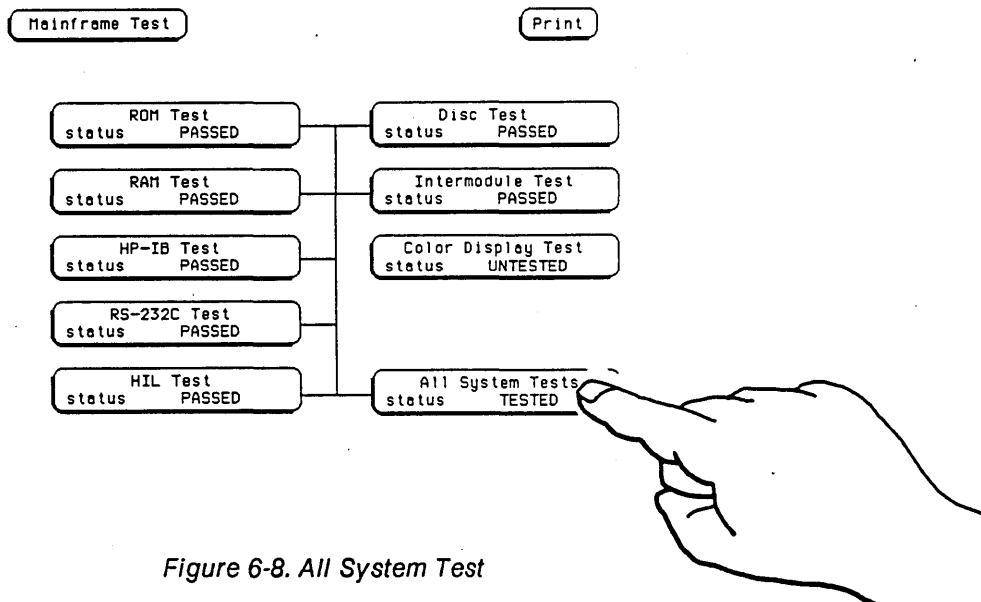

Figure 6-8. All System Test

When the tests are completed, the status advisory for each test will change from UNTESTED to either PASSED or FAILED. The All System Tests advisory will change from UNTESTED to TESTED. Also note that the Color Display Test status will remain UNTESTED.

If any tests fail, refer to the troubleshooting paragraph this in section.

THE COLOR DISPLAY CHECK

The Color Display Check may be used to test the display.

This check is not normally needed. These screens are primarily used when the color module requires adjusting. Refer to Section IV of this manual for the adjustment procedure.

To check for color purity, follow the procedure below:

- a. From the Mainframe Test menu, select the Color Display Test. The white cross hatch pattern will be displayed first. This pattern is used for the color module geometry adjustments.
- b. Touch the **Continue** field. The white raster pattern is now displayed. With every touch of the **Continue** field, the next color test pattern will be displayed (see figure 6-9).

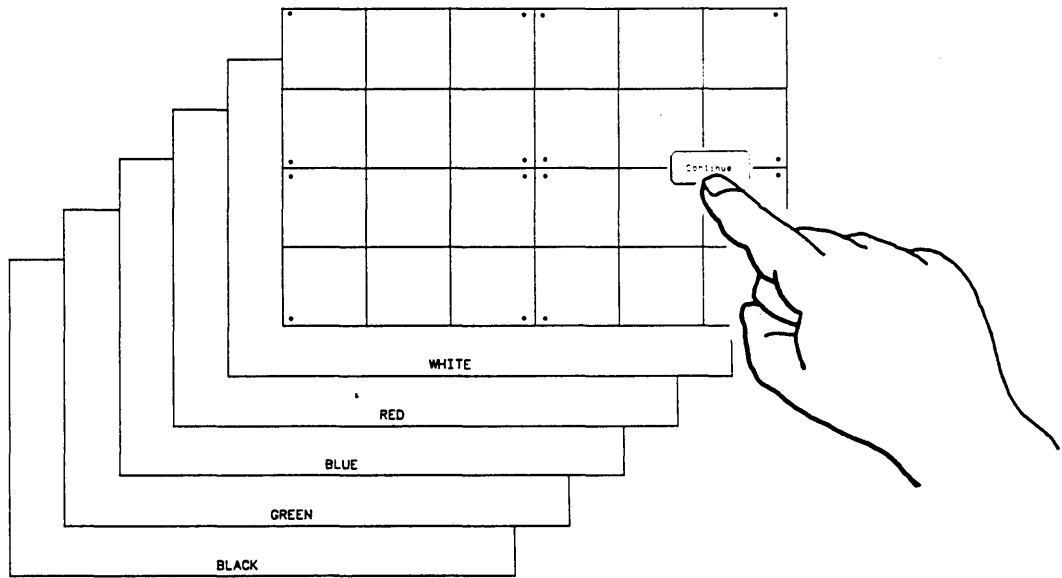

Figure 6-9. Selecting the Color Display Test Patterns.

- c. Touch **Continue** from the black raster pattern to redisplay the Mainframe Test menu. Notice that the Display Test status has changed from UNTESTED to TESTED.

PERFORMING THE MAINFRAME TESTS

Only the ROM Test will be described in detail since all tests are accessed and performed in the same manner. A description of the remainder of the mainframe tests is provided at the end of the ROM Test procedure.

To perform the mainframe tests, follow the procedure outlined below.

ROM Test

This test checks the Mainframe ROMs. The test computes a checksum for the ROM and compares it to a stored value.

- a. Display the Mainframe Test menu (see figure 6-10).

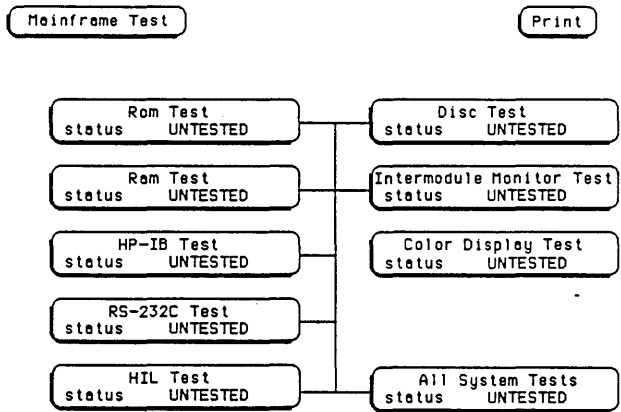

Figure 6-10. Mainframe Test Menu

- b. Touch the ROM Test field. The ROM Test screen will be displayed (figure 6-11).

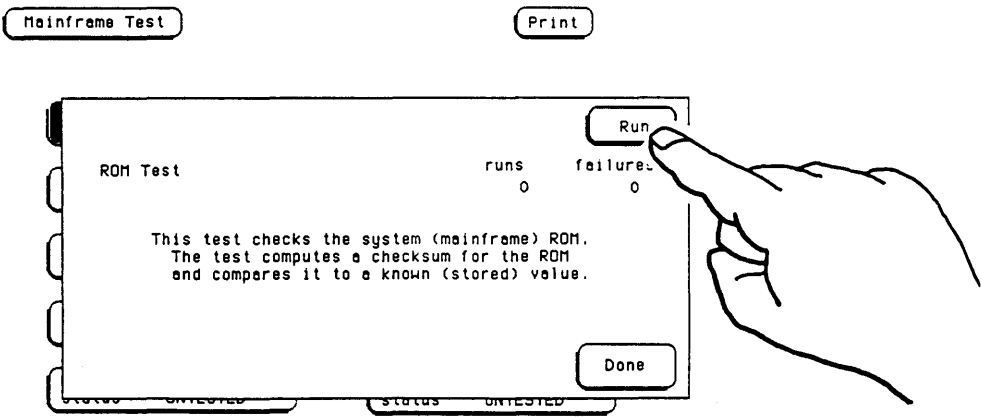

Figure 6-11. ROM Test Screen

c. Touch the **Run** field and slide your finger downward on screen to **Single**, **Repetitive** or the **Cancel** field and lift your finger off the screen. The test sequence is not started if the **Cancel** field is selected (see figure 6-12).

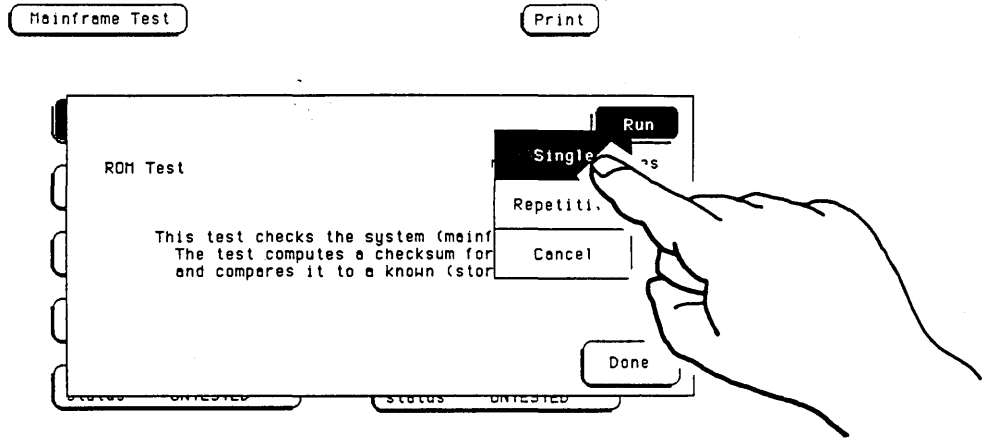

Figure 6-12. Choosing the Single or Repetitive Mode.

In the Single mode, the test is only done once. In the Repetitive mode, the test repeats itself until the **Stop** or **Done** field is touched. The test results are also shown on this screen. The **run** column contains the number of times the test has been performed and the **failures** column contains the number of times the test has failed (see figure 6-13). The run/fail count is reset to zero when the **Done** field is selected.

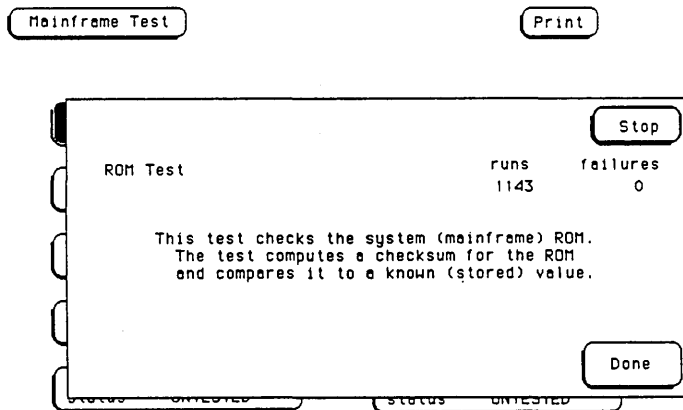

Figure 6-13. ROM Test in the Repetitive Mode with Test Results.

d. To exit the ROM Test, touch the **Done** field and the Mainframe Test menu is redisplayed. The test status will have changed to either **PASSED** or **FAILED**.

EXITING THE MAINFRAME TEST SYSTEM

The Mainframe Test System may be exited any time after a test has been completed.

Perform the following steps to exit the system:

- a. From any test screen, touch the **Done** field to redisplay the Mainframe Test menu.
- b. Select the **Mainframe Test** field and the **Test System** field from the pop-up menu (see figure 6-14). The Test System Configuration will be redisplayed.

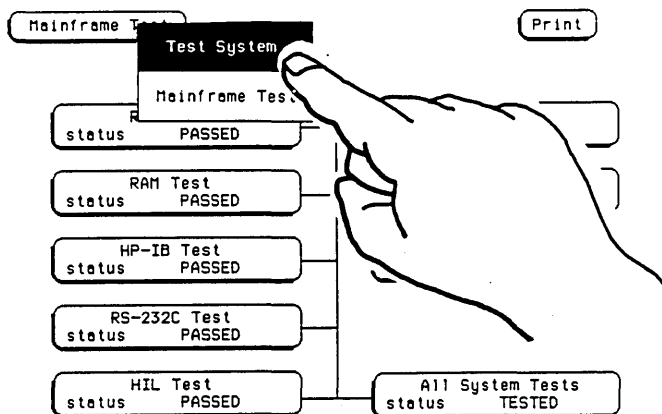

Figure 6-14. Exiting the Mainframe Test System

- c. Select the **Configuration** field and touch **Exit Test** (see figure 6-15).

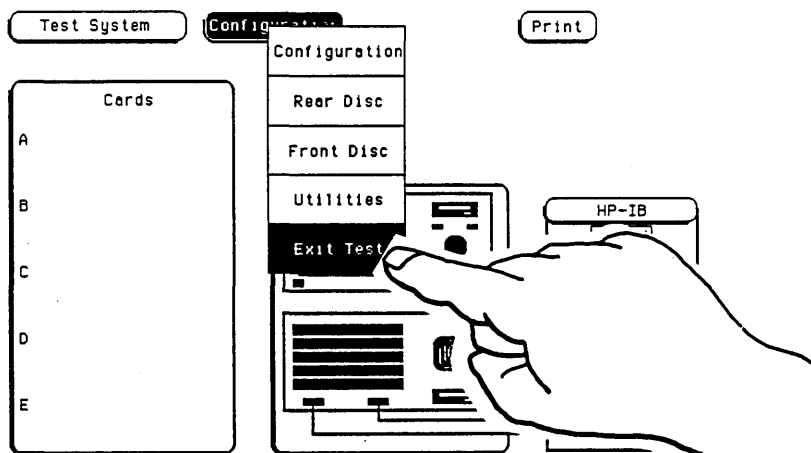

Figure 6-15. Exiting Test Configuration

- d. Ensure that the operating system software is installed in a disc drive. Touch the field in the center of the screen to reload the mainframe operating system. After the operating system has been reloaded, the System configuration will be redisplayed.

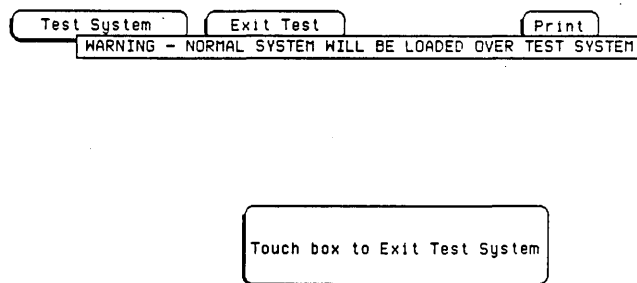

Figure 6-16. Reloading the Mainframe System

DESCRIPTION OF MAINFRAME TESTS

Below is a brief description of each remaining mainframe test. The tests are accessed and performed in the same manner as the ROM Test. If any tests fail, refer to the troubleshooting paragraph in this section.

RAM Test

This test checks the mainframe RAM. The test performs a non-destructive pattern write/read at every location. The initial RAM contents are restored after the test.

HP-IB Test

The HP-IB Test checks the basic interface functions of the HP-IB port. Only the internal portions of the port circuitry is tested.

RS-232C Test

This test checks the basic interface functions of the RS-232-C port. Both internal and external portions of the port circuitry are tested.

In order for the external loop back test to pass, the RS-232-C loopback connector must be installed on the microprocessor board rear panel.

HIL Test

The HIL Test consists of three parts: the HIL controller test, the front panel test, and the touchscreen test. All three tests return a pass/fail message. This test cannot be run repetitively. Every time the **Run** field is touched the HIL test sequence is repeated. The test results are displayed in the same manner as the other tests.

Disc Test

This test checks both disc drives. The test checks for the correct disc format and the system's ability to read from and write to a test track on both discs.

The test will fail if a formatted disc is not installed in both disc drives, or if the write protect on the disc itself is engaged.

Intermodule Test

The Intermodule Test checks the functions of the mainframe's intermodule arm/trigger circuits. Also displayed on the test screen are the option board card identifications.

6-9. TROUBLESHOOTING

This paragraph contains troubleshooting information for the HP 16500A mainframe. Troubleshooting an instrument failure to the assembly level may be accomplished using the troubleshooting flow charts provided in this paragraph.

The charts are organized into the Main, the Color Module, the Power Supply and the System Boot troubleshooting flow charts. A chart for each of the tests of the Mainframe Test system is also provided.

If the instrument passes all power-up tests (see figure 6-17), the power supply, color module and portions of the microprocessor board are working correctly. The remainder of the tests and troubleshooting flow charts are used to check the mainframe peripheral interfaces on the microprocessor board.

Only a voltmeter, a system disc, a second formatted disc and the RS-232-C loop-back connector are required to perform the tests. Before performing any tests, install the RS-232-C loop-back connector, the system disc and the formatted disc in the other disc drive. Also remove all optional boards from the mainframe.

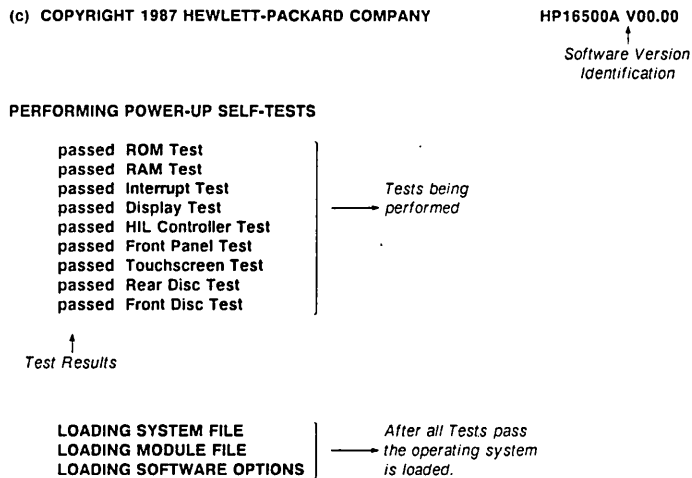
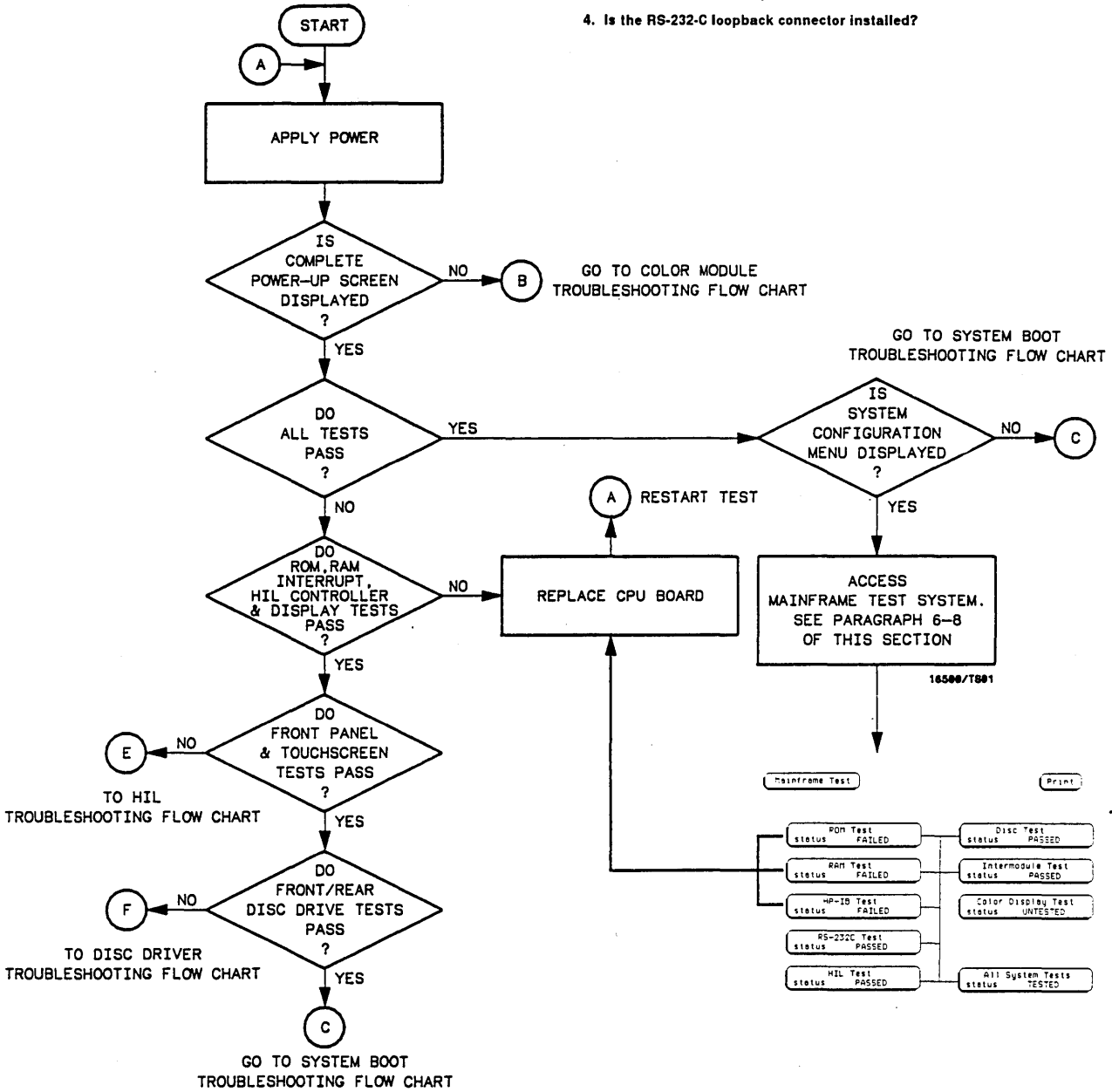

Figure 6-17. HP 16500A Power-up Test Screen

Main Troubleshooting Flow Chart

PRETEST CHECK LIST:

1. Are all optional boards removed from the mainframe?
2. Is an operating disc installed in one disc drive?
3. Is a formatted, unwrite protected disc installed in the other drive?
4. Is the RS-232-C loopback connector installed?



MAIN TROUBLESHOOTING

Figure 6-18. Main Troubleshooting Flow Chart

COLOR MODULE TROUBLESHOOTING FLOW CHART

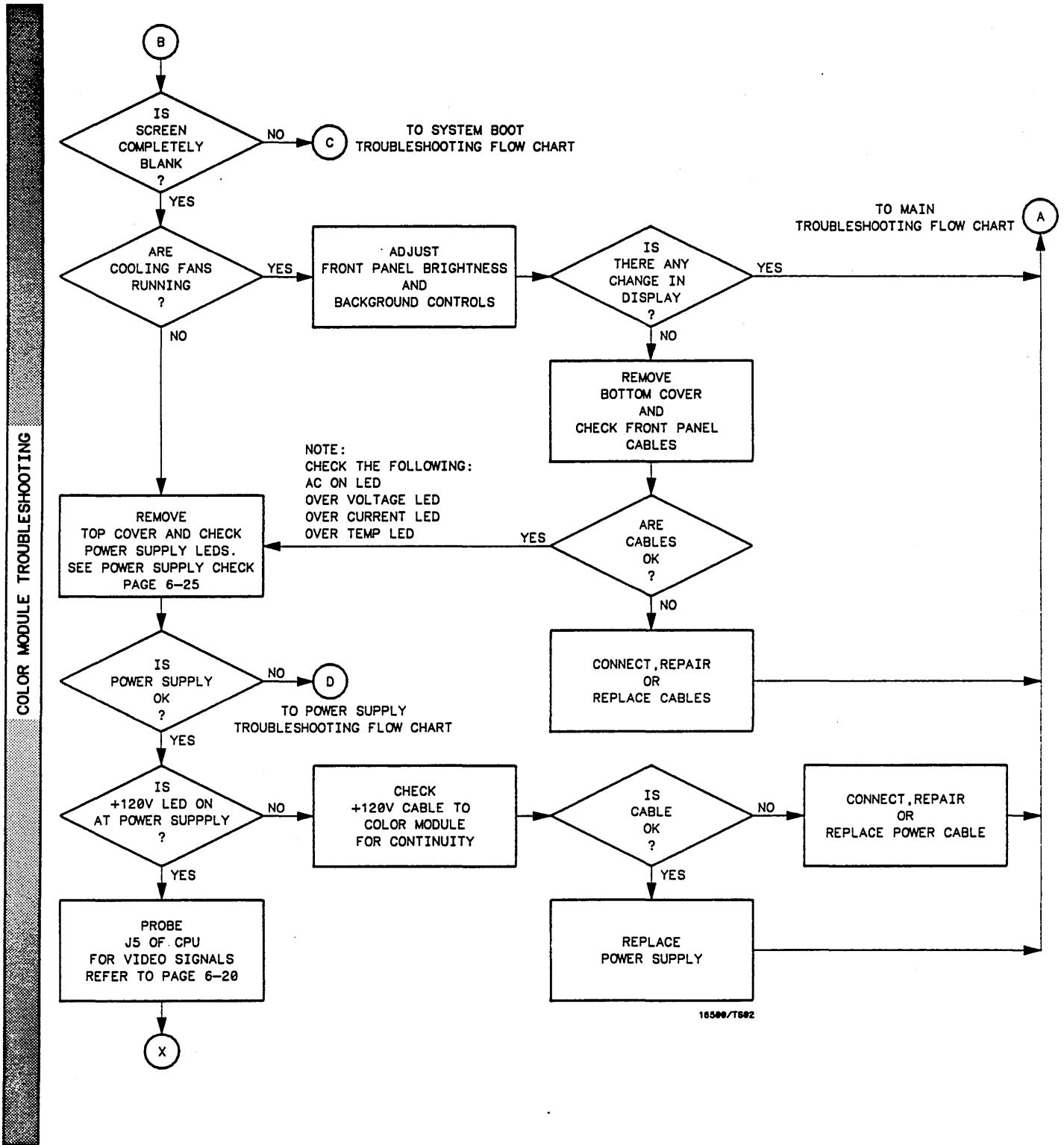

16500/T692

Figure 6-19. Color Module Troubleshooting Flow Chart

COLOR MODULE TROUBLESHOOTING FLOW CHART (CONTINUED)

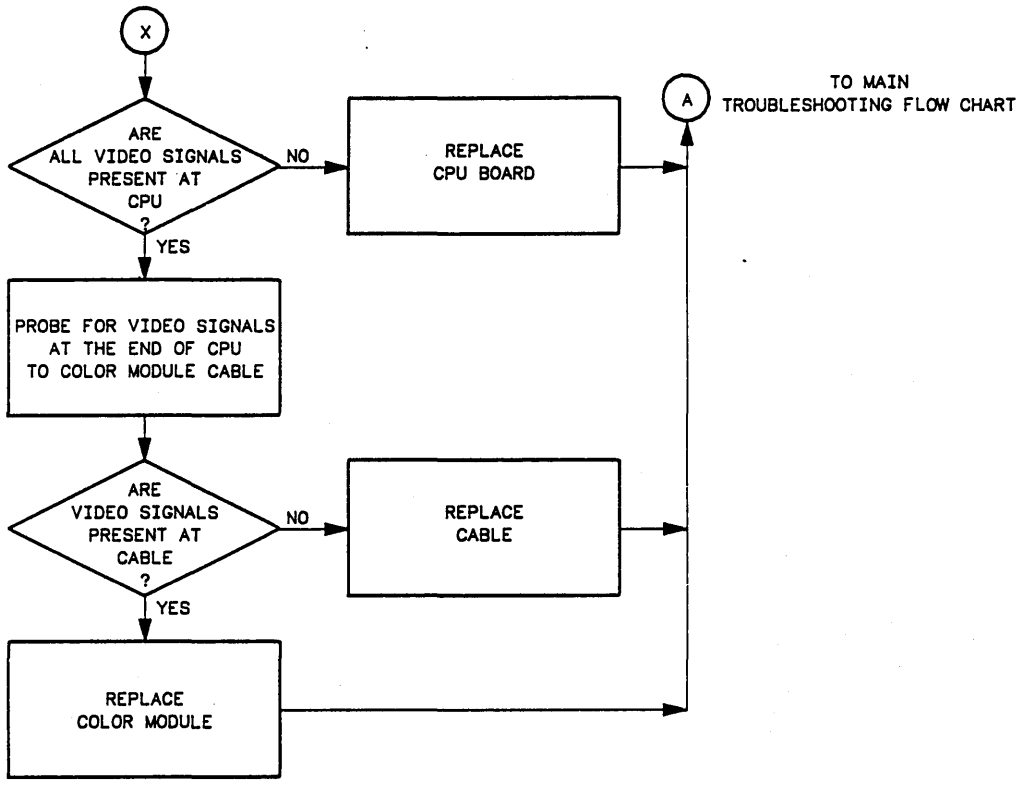

16500/T003

COLOR MODULE TROUBLESHOOTING

CHECKING FOR THE COLOR MODULE SIGNALS

1. Disconnect power from instrument.
2. Disconnect CPU to Color Module cable at the CPU board end.
3. Load operating system into one disc drive and apply power.
4. Allow enough time for the operating system to load.
5. Probe J5 pins 3 and 7 of the CPU board for the horizontal and vertical sync signals.
6. Probe J5 pins 21, 29, and 37 of the CPU board for red, green and blue display data.
7. Return to color module troubleshooting flow chart.

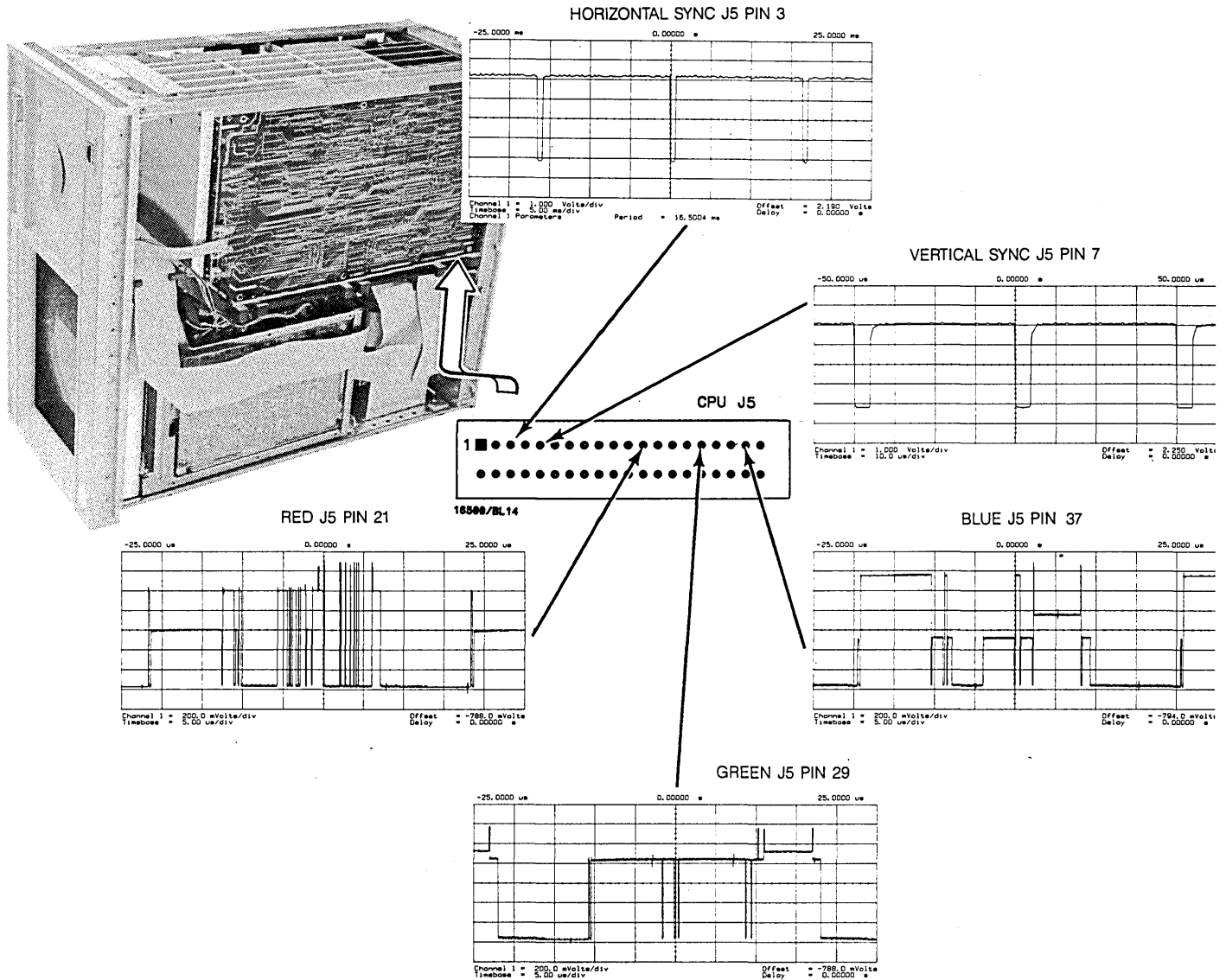
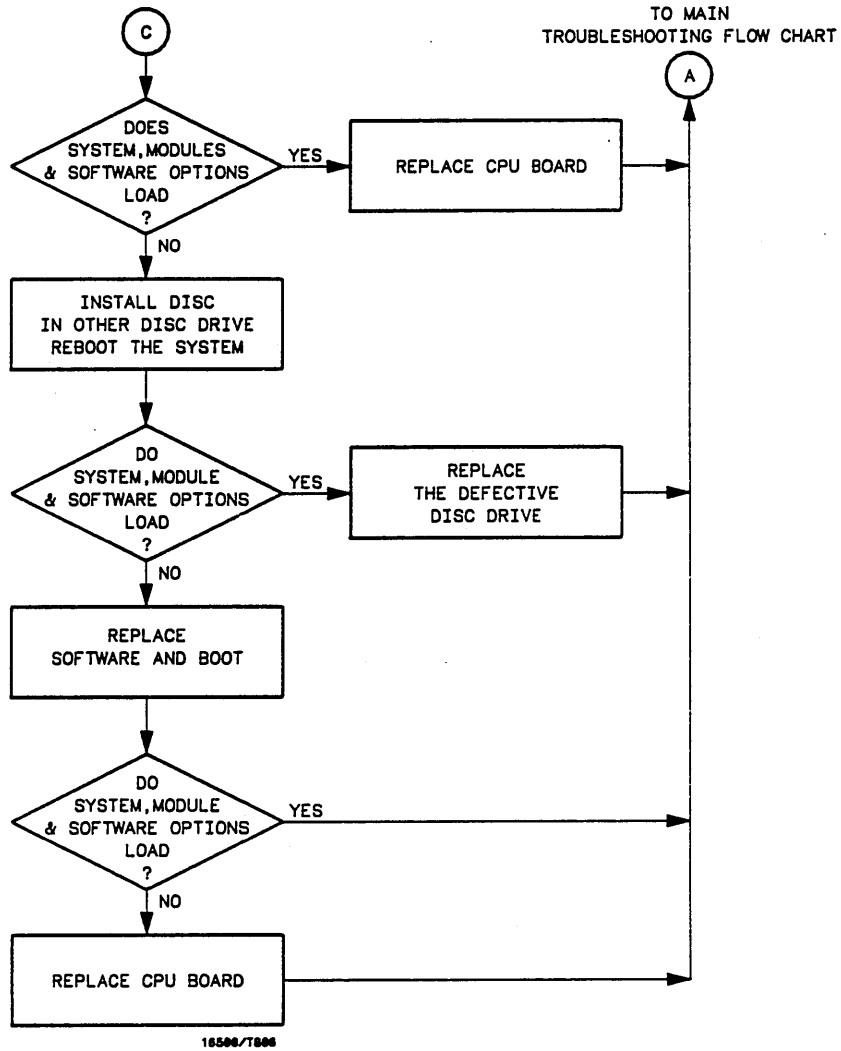

Figure 6-20. Checking for Color Module Signals

CHECKING THE CPU TO COLOR MODULE CABLE

1. Remove power from instrument and reconnect cable to CPU board at J5.
2. Disconnect cable at color module end. Apply power to the instrument.
3. Probe same pin numbers on the cable for the signals as above.
4. Return to color module troubleshooting flow chart.

SYSTEM BOOT TROUBLESHOOTING CHART



SYSTEM BOOT TROUBLESHOOTING

Figure 6-21. System Boot Troubleshooting Flow Chart

POWER SUPPLY TROUBLESHOOTING FLOW CHART

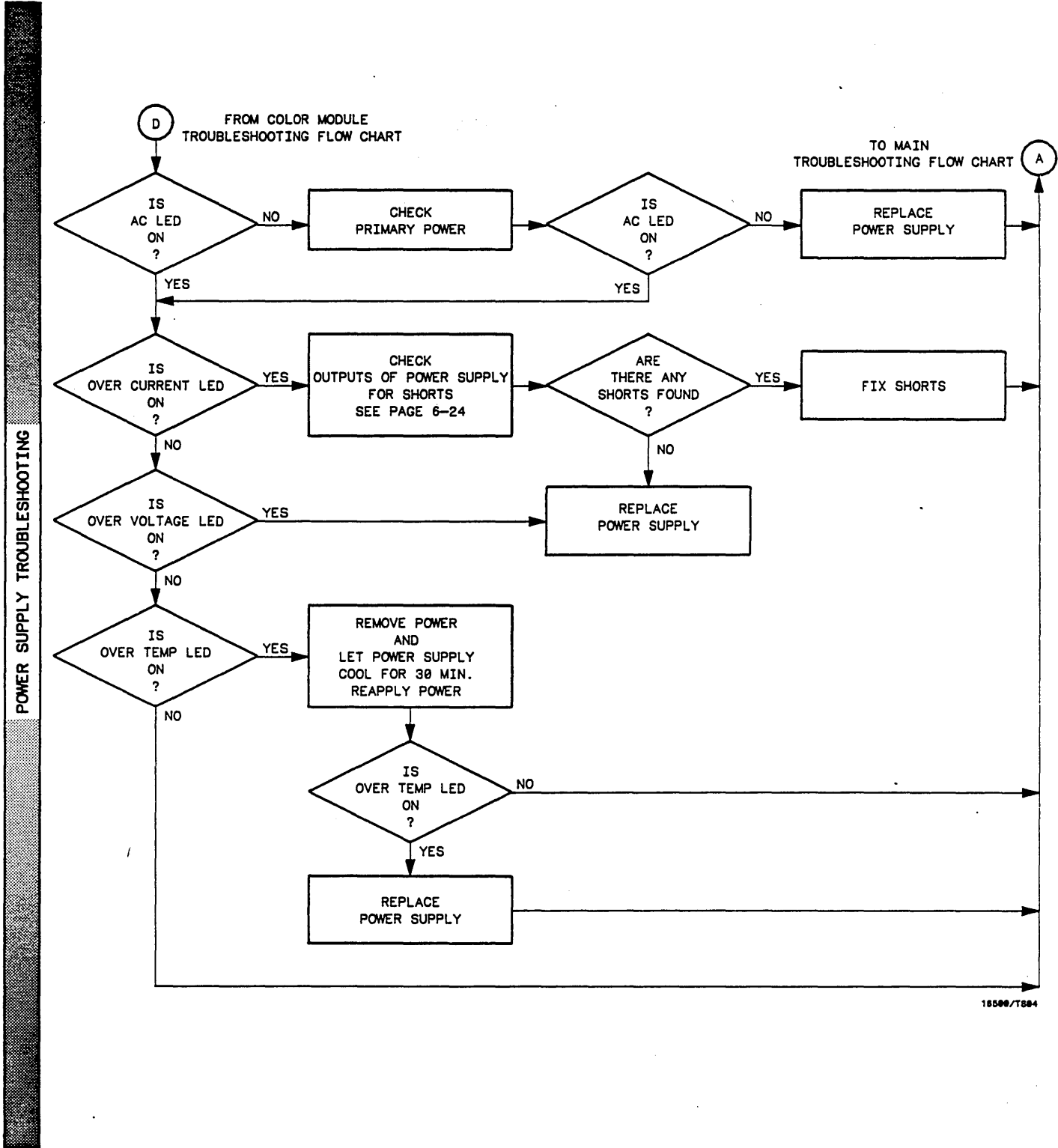

16500/T584

Figure 6-22. Power Supply Troubleshooting flow Chart

POWER SUPPLY CHECK

- 1. Apply power to the instrument and check for the following indications:
 - a. Is the AC LED on?
 - b. Is the Over Temp, Over Current or Over Voltage LED on?

The +120V supply is checked later in the color module troubleshooting flow chart

- 2. Return to the power supply troubleshooting flow chart.

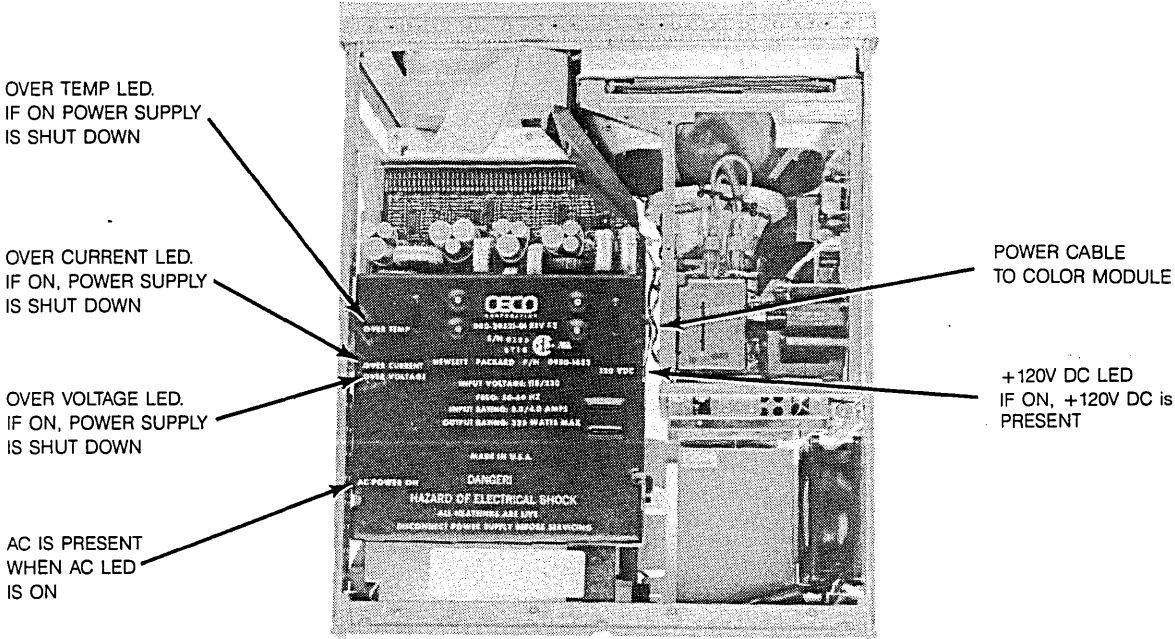

Figure 6-23. Power Supply Check

PROCEDURE FOR CHECKING POWER SUPPLIES SHORTED TO GROUND.

1. Remove Power from Instrument.
2. Using a DVM, measure the resistance to ground of each power supply.

Use the figure below for power supply pin assignments.

Power Supply Pin Assignments

Power Supply	Pin Number
+5V	1-5
+5V Remote Sense	6
+3.5V	7-10
+12V	11
-12V	12
GND	14-20
GND Remote Sense	21
Power Valid	22
-3.25V Remote Sense	23
-3.25V	24-30
-5.2V Current Limit	31
-5.2V Remote Sense	32
-5.2V	33-37
Remote on/off	38
+120V	Accessible at the color module power connector

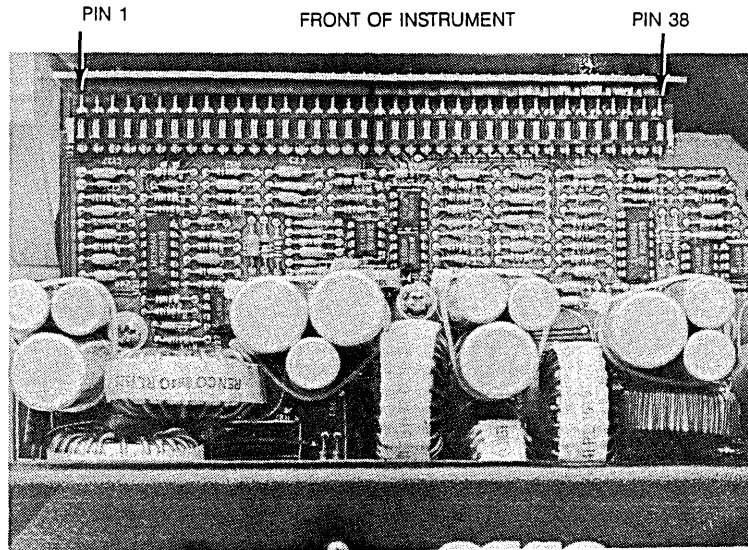
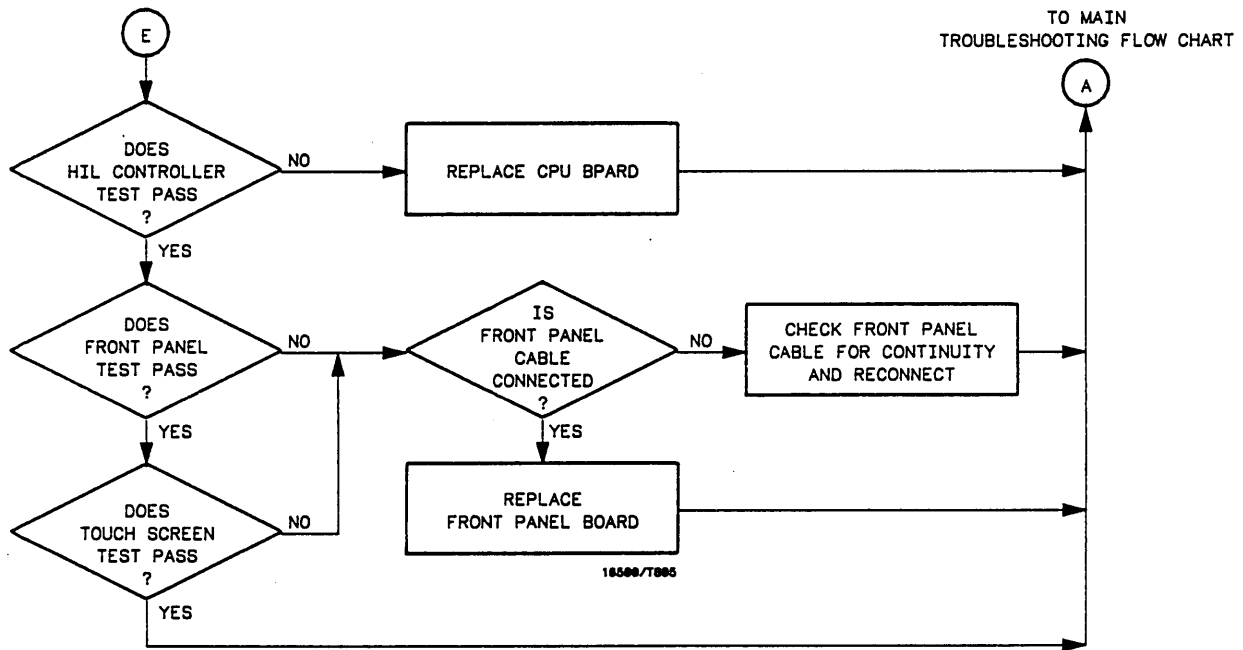
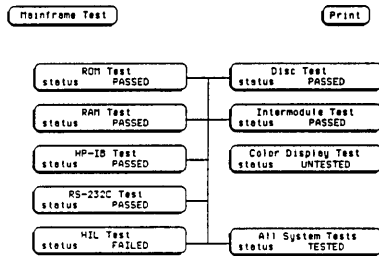

Figure 6-24. Checking Power Supply Resistance to Ground

HIL TROUBLESHOOTING FLOW CHART



HIL TROUBLESHOOTING

Figure 6-25. HIL Troubleshooting Flow Chart

DISC DRIVE TROUBLESHOOTING FLOW CHART

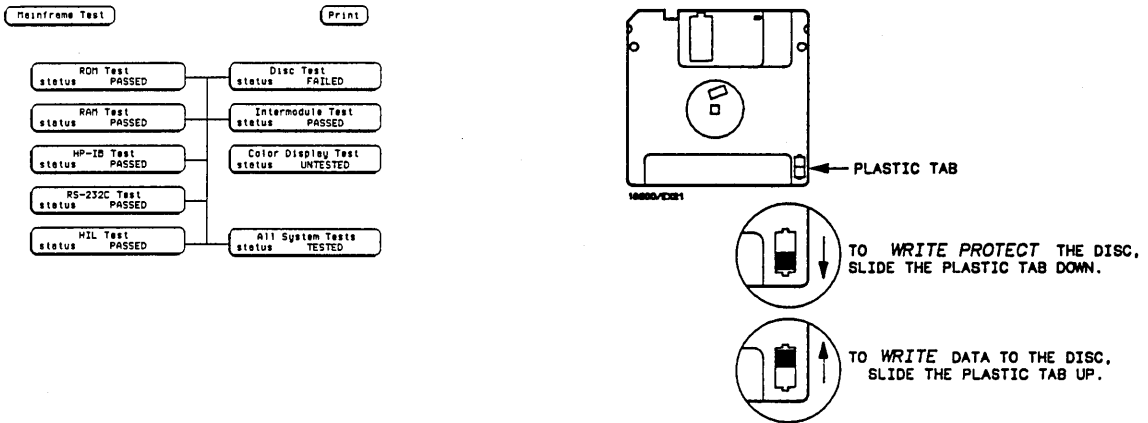

DISC DRIVE TROUBLESHOOTING

FROM MAIN TROUBLESHOOTING FLOW DIAGRAM

TO MAIN TROUBLESHOOTING FLOW CHART

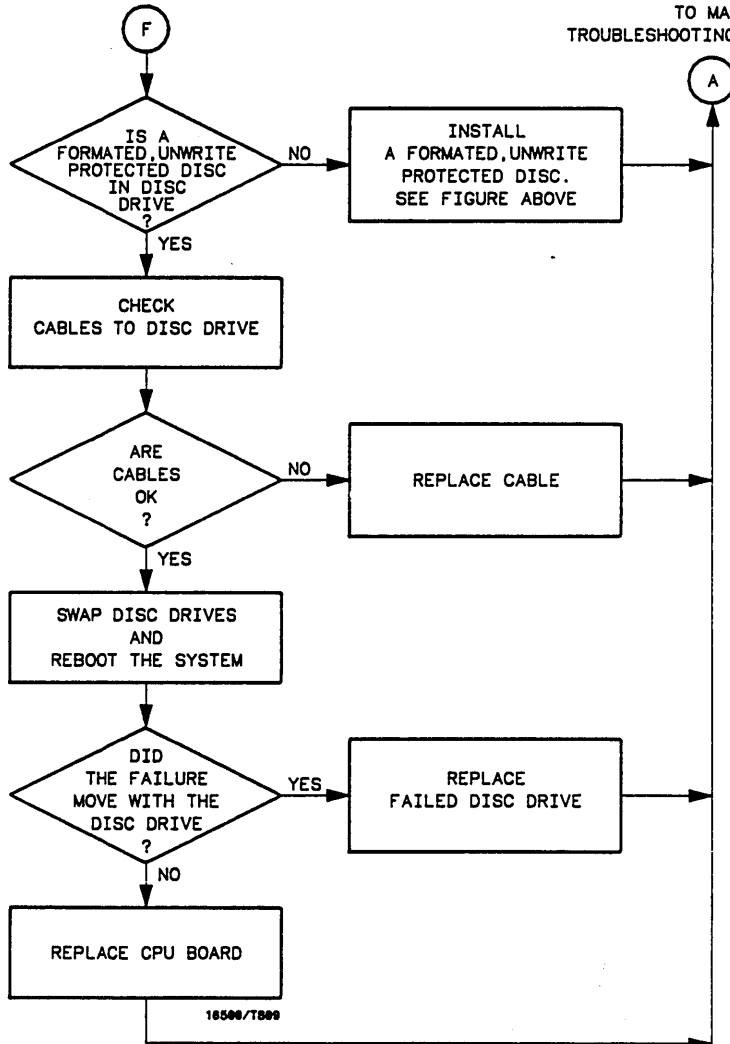
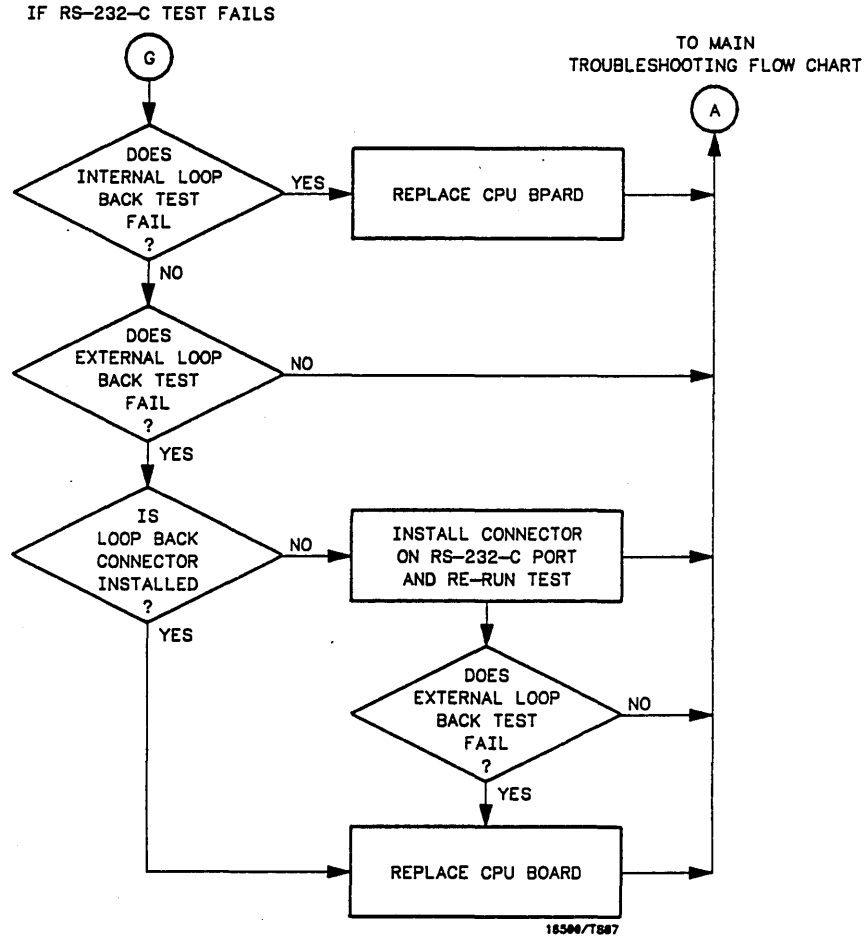
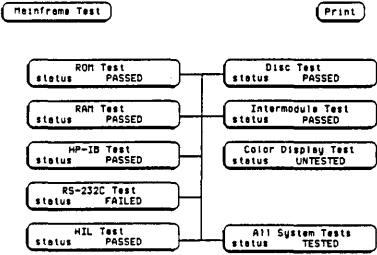

Figure 6-26. Disc Drive Troubleshooting Flow Chart

RS-232-C TROUBLESHOOTING FLOW CHART



RS-232-C TROUBLESHOOTING

Figure 6-27. RS-232-C Troubleshooting Flow Chart

INTERMODULE TROUBLESHOOTING FLOW CHART

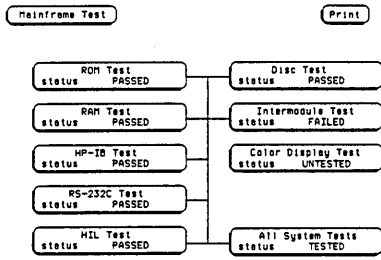

INTERMODULE TROUBLESHOOTING

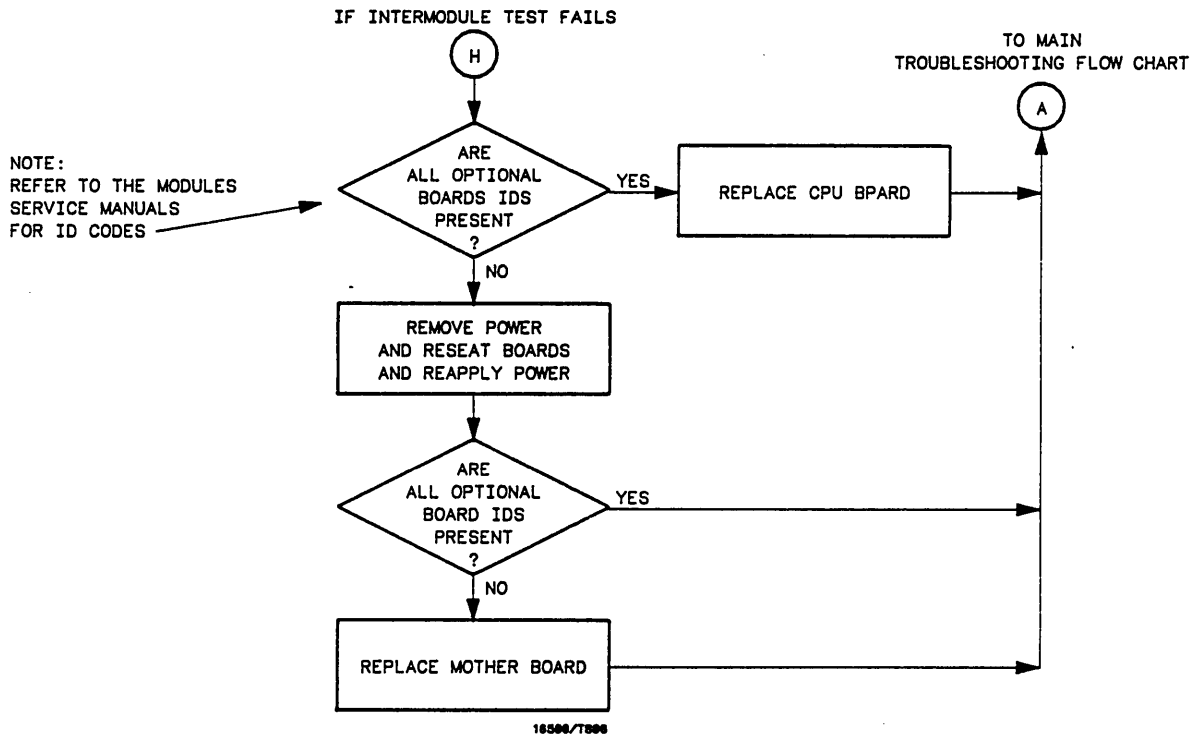

Figure 6-28. Intermodule Troubleshooting Flow Chart

6-10. REPAIR

The repair procedures in this section are provided to facilitate mainframe repair. After diagnosing the defective assembly, refer to the appropriate repair procedure and follow the steps provided.

Assembly identification is given in figure 6-29, and the assembly to repair paragraph cross-reference is given in table 6-1.

After repairs have been made, perform the power-up test and all tests of the mainframe test system.

Table 6-1. Replaceable Assemblies

<u>PARAGRAPH NUMBER</u>	<u>ASSEMBLY TO BE REPLACED</u>
6-11	Power Supply
6-12	Microprocessor Board
6-13	Mother Board
6-14	Front Panel Board
6-15	Display Module
6-16	Front Disc Drive
6-17	Rear Disc Drive
6-18	Cooling Fans

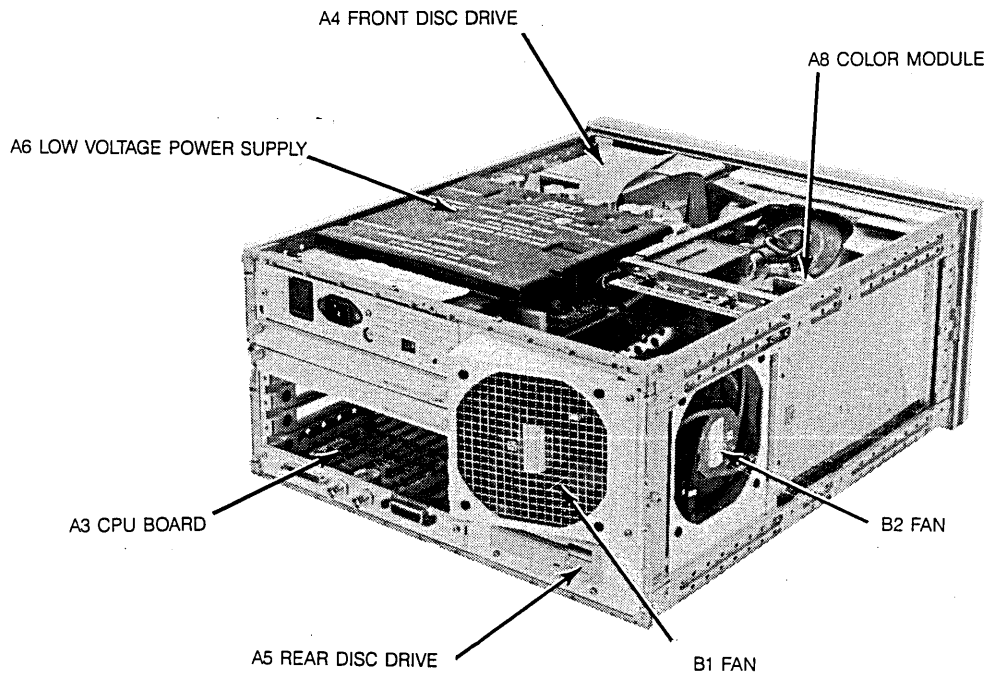

Figure 6-29. Replaceable Assembly Identification

WARNING

*This instrument is equipped with a standby switch on the front panel which **DOES NOT** de-energize the power supply when switched to the STBY position. To avoid shock hazards capable of causing injury or death, disconnect the power cord for all of the assembly replacement procedures.*

6-11. POWER SUPPLY REPLACEMENT

- a. Remove Power Cord, top cover and left side cover (as viewed from the rear of the instrument).
- b. Remove front disc drive and disc drive bottom bracket. Leave the disc drive and bracket in one assembly. Leave disc drive assembly connected to the cable and set it aside. Refer to paragraph 6-12 for instruction on front disc removal.
- c. Using a Torx T-8 ® driver, remove power supply rear panel (see figure 6-30).

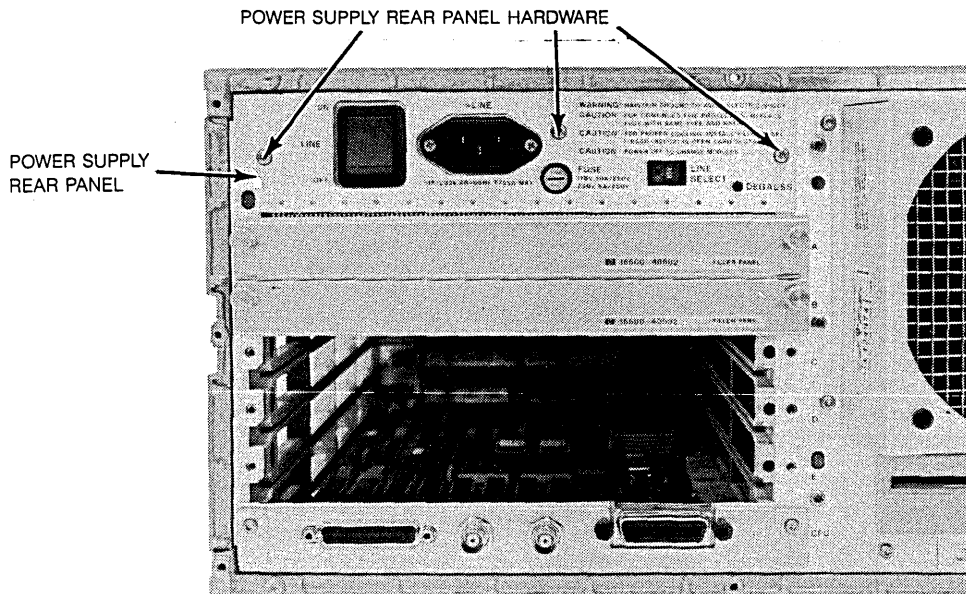

Figure 6-30. Power Supply Rear Panel

- d. Disconnect display module power cable (refer to figure 6-31).

- e. With a Torx T-15 driver remove power supply mounting screws (4 screws).

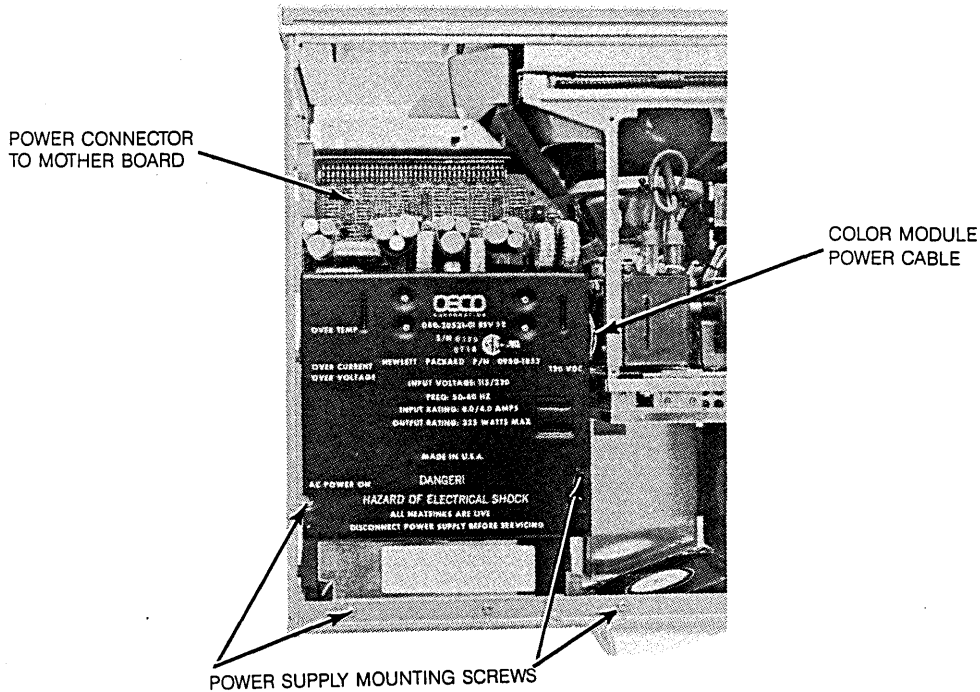

Figure 6-31. Power Supply Mounting Screws and Display Power Cable

- f. Gently pull power supply towards the mainframe rear panel until it disconnects from front connector.
- g. Carefully lift the front end of the power supply and guide it out of the mainframe.
- h. Reverse the above procedure to install the new power supply. Ensure that the front connector and rail guides are properly aligned before pushing the power supply into place (see figure 6-32 and 6-33).

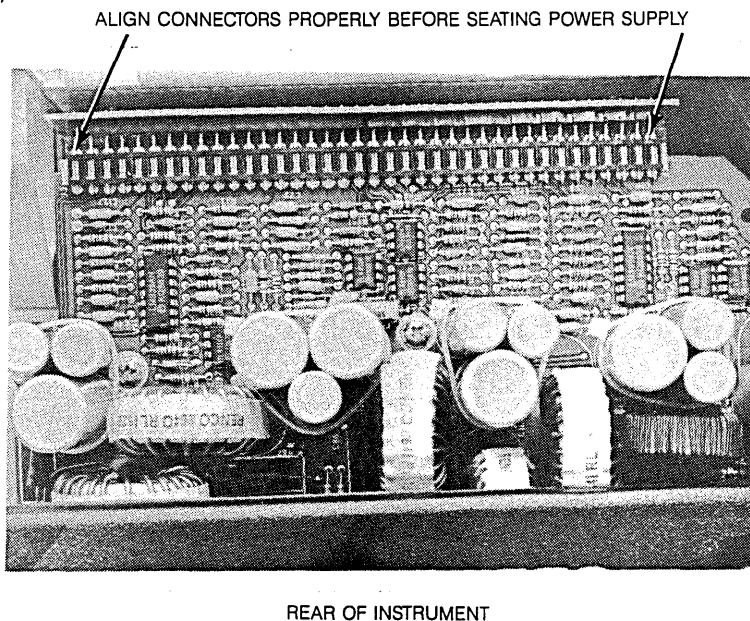

Figure 6-32. Power Supply Connector Alignment

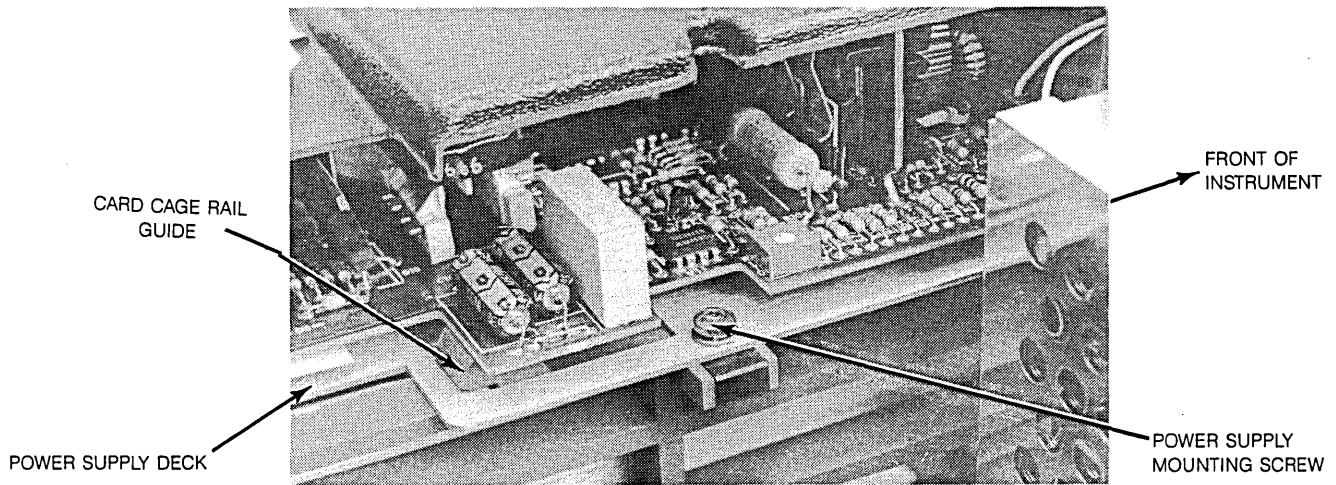

Figure 6-33. Power Supply Rail Alignment

- i. Reinstall power supply hardware, power supply rear panel and display module power cable.
- j. Complete installation by attaching all covers.

6-12. MICROPROCESSOR BOARD REPLACEMENT

- a. Remove power cord and all modules from mainframe.
- b. Remove bottom cover. Disconnect the two microprocessor cables. Note that the front cable is connected to the rear disc drive and the other cable is connected to the display module (see figure 6-34).

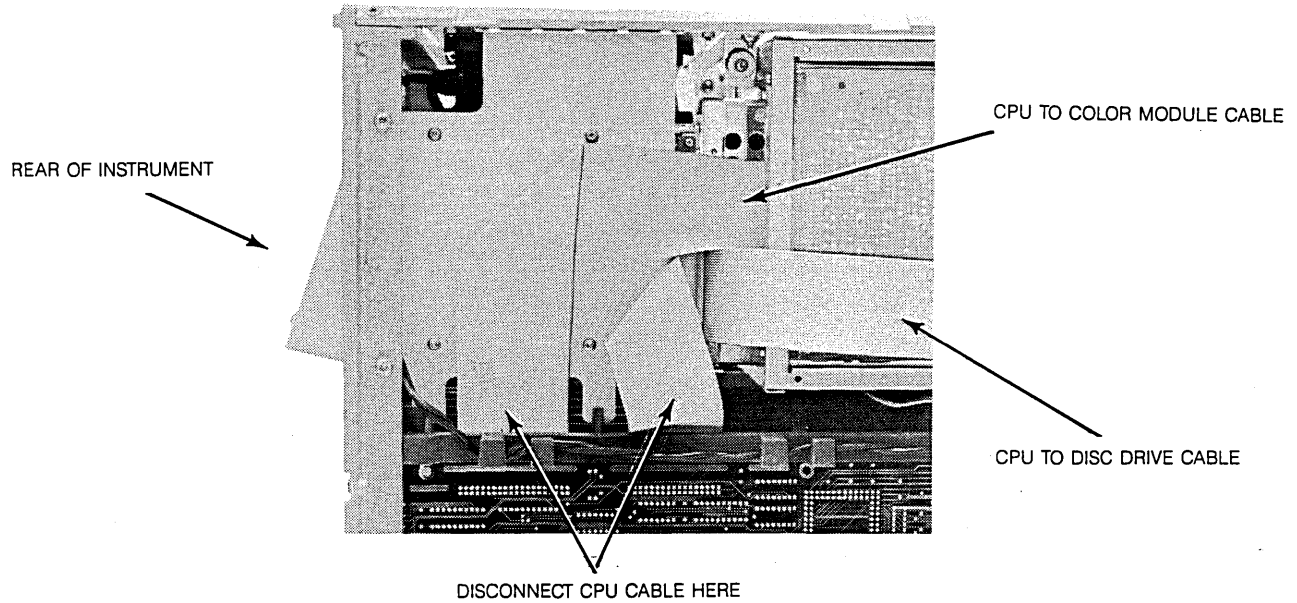

Figure 6-34. Microprocessor Cable Location.

- c. With a Torx T-10 driver, remove the two rear panel mounting screws (see figure 6-35).

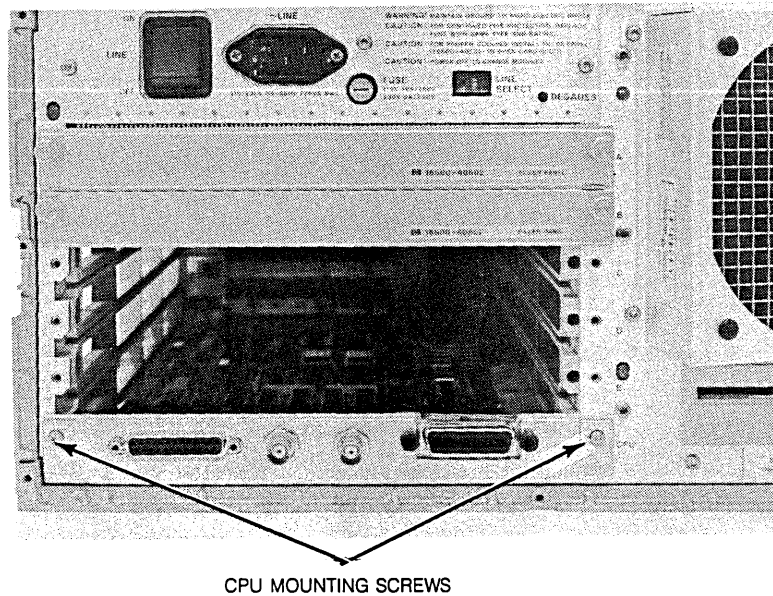

Figure 6-35. Microprocessor Board Mounting Screws

- d. Carefully slide the board out of the mainframe.
- e. Reverse the above procedure to install the new board. Attach the disc drive cable to the front connector and the display module cable to the rear connector. Ensure that the heat sensor immediately to the front of the disc drive connector is not damaged or moved.
- f. Return instrument to normal configuration by installing all modules and attach bottom cover.

6-13. MOTHER BOARD REPLACEMENT

- a. Remove power cord, all modules, top, bottom and left cover.
- b. Remove power supply rear panel and the four power supply mounting screws. Refer to figure 6-36 for power supply hardware identification. Pull power supply toward rear panel to disconnect it from motherboard.

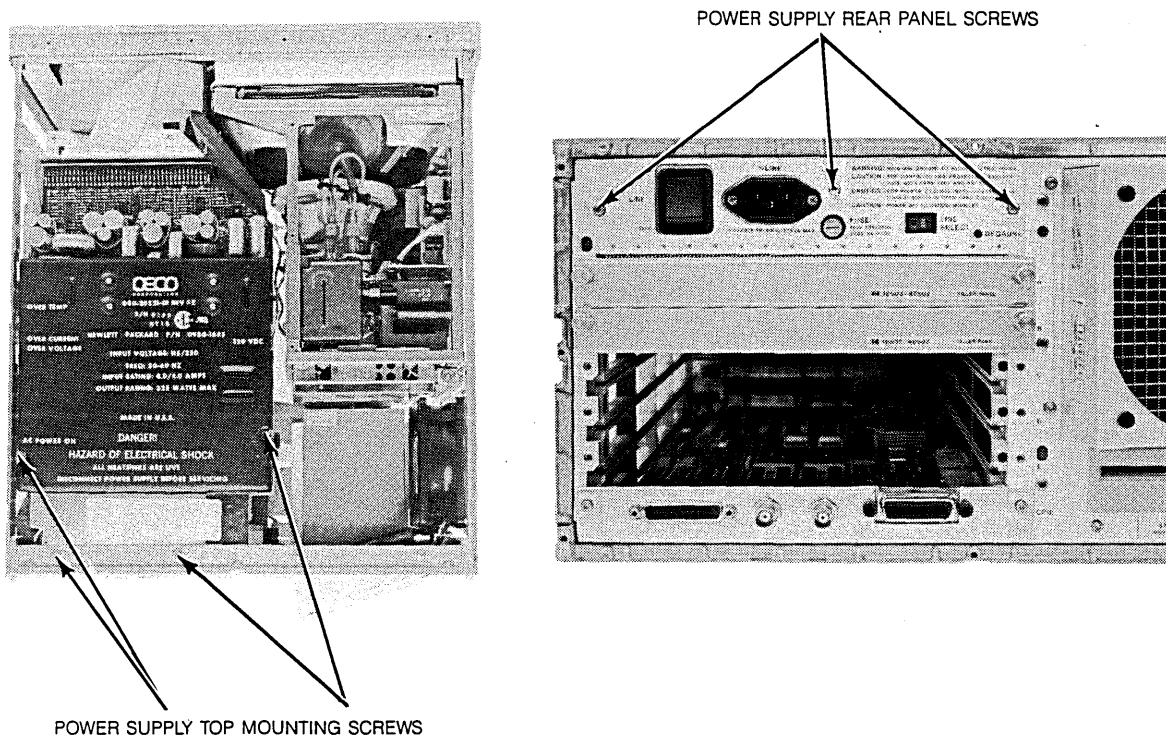

Figure 6-36. Power Supply Hardware Identification

- c. Stand instrument on its left side. Disconnect the two flat cables from the microprocessor board. Note the orientation of the cables.
- d. Remove the two microprocessor mounting screws and gently slide the board out of the mainframe (see figure 6-36).
- e. Disconnect fan power cable and front panel cable from mother board. Refer to figure 6-37.

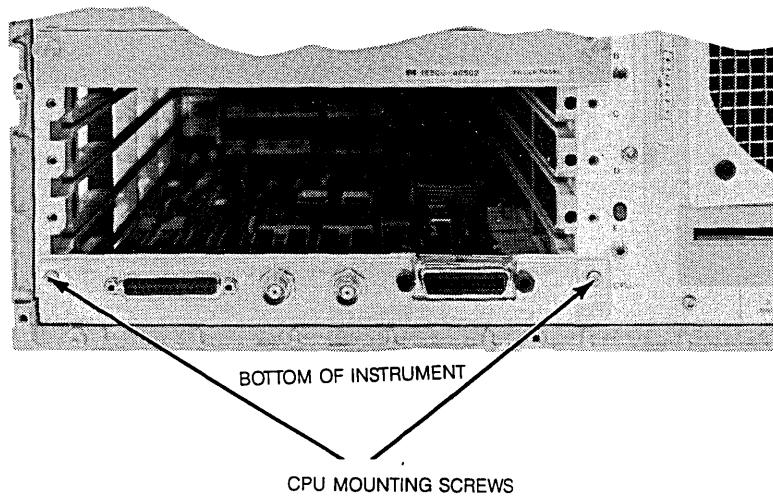

Figure 6-37. Microprocessor Board Removal

- f. With a Torx T-10 driver, remove the six mother board mounting screws. Lift the board from mainframe through the bottom of the instrument (see figure 6-38).

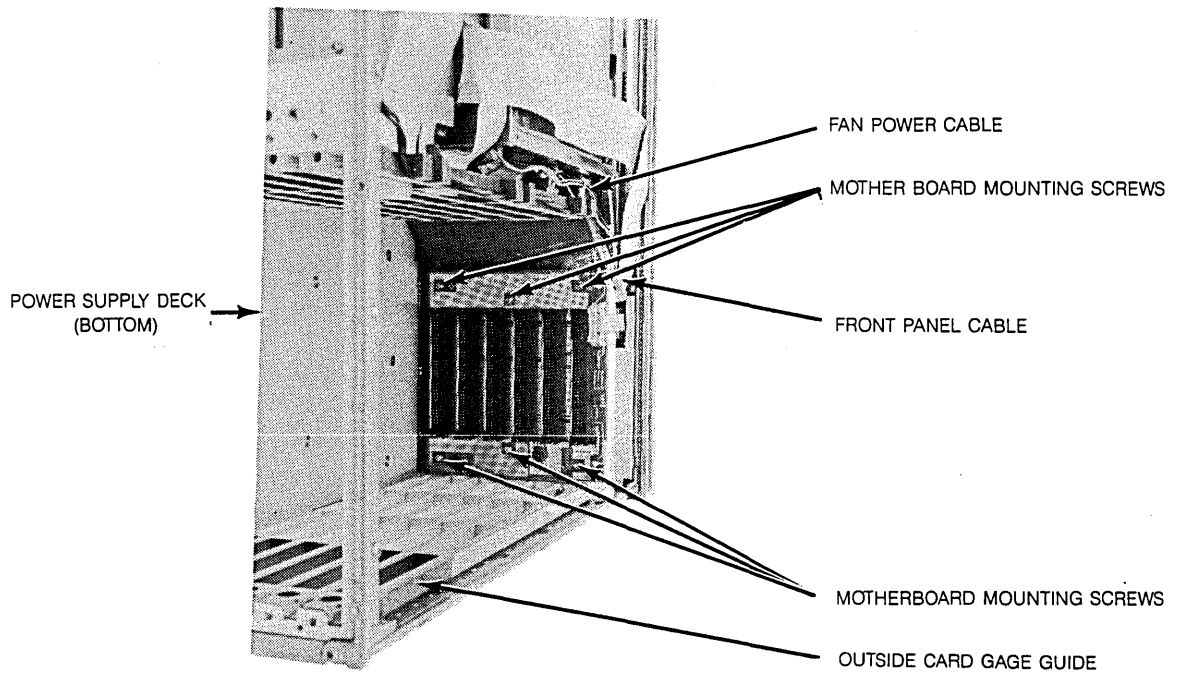

Figure 6-38. Mother Board Removal

- g. Install new mother board and reconnect the fan power cable and front panel cable.
- h. Reinstall the microprocessor board and cables. Reconnect the power supply.
- i. Replace all modules and reattach all covers.

6-14. FRONT PANEL BOARD REPLACEMENT

- a. Remove power cord, bottom and top covers. Remove front disc drive (see paragraph 6-16).
- b. Disconnect the two cables from front panel board (see figure 6-39).

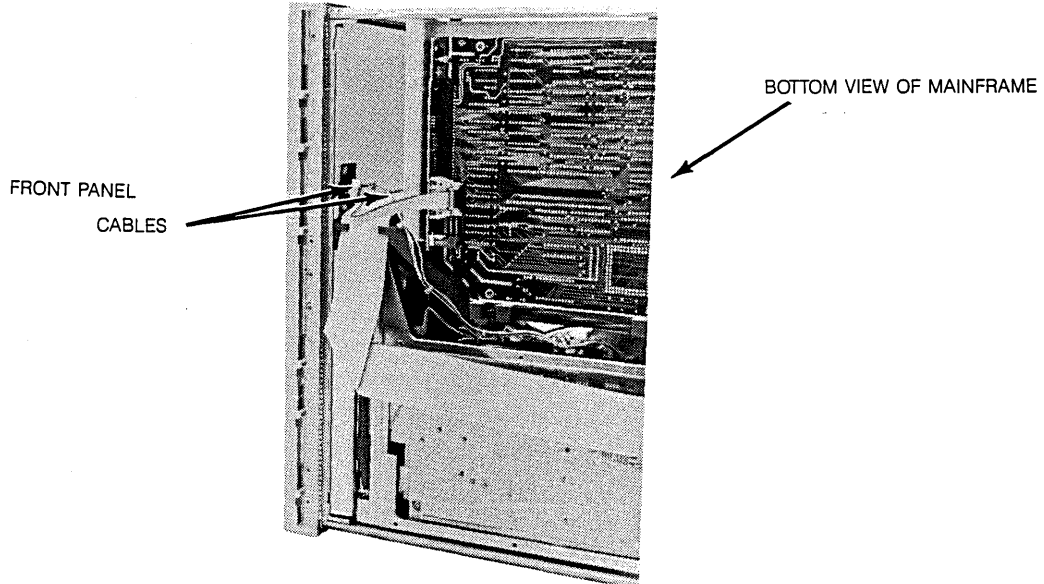

Figure 6-39. Front Panel Cable Removal

- c. Remove the four front panel assembly mounting screws from top casting as shown in figure 6-40. Use a Torx T-15 driver.

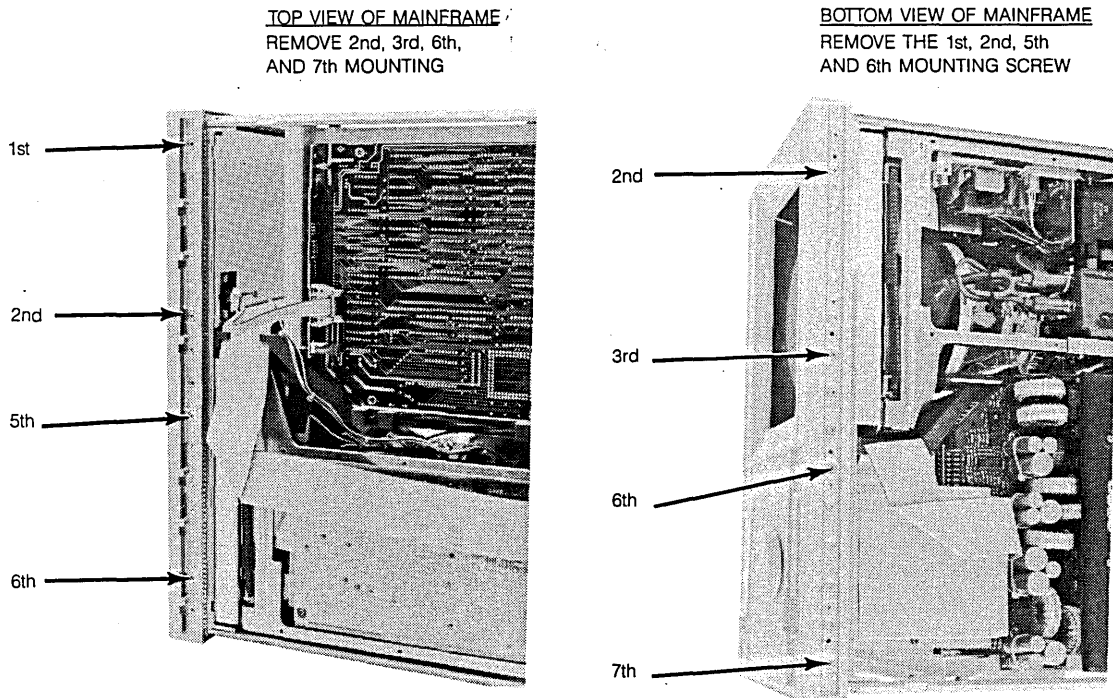

Figure 6-40. Front Panel Mounting Screws Identification

- d. With a Torx T-15 driver, remove the four bottom front panel mounting screws (see figure 6-40).
- e. Remove front panel and shield by pushing on the back of the panel from the inside of the instrument.
- f. Very carefully remove the shield from the assembly. The shield is very fragile and must be replaced if it is bent or damaged in any way.
- g. Unplug the knob cable. Using a Torx T-10 driver remove the seven front panel mounting screws. Use figure 6-41 to identify the mounting screws. Remove board from front panel.

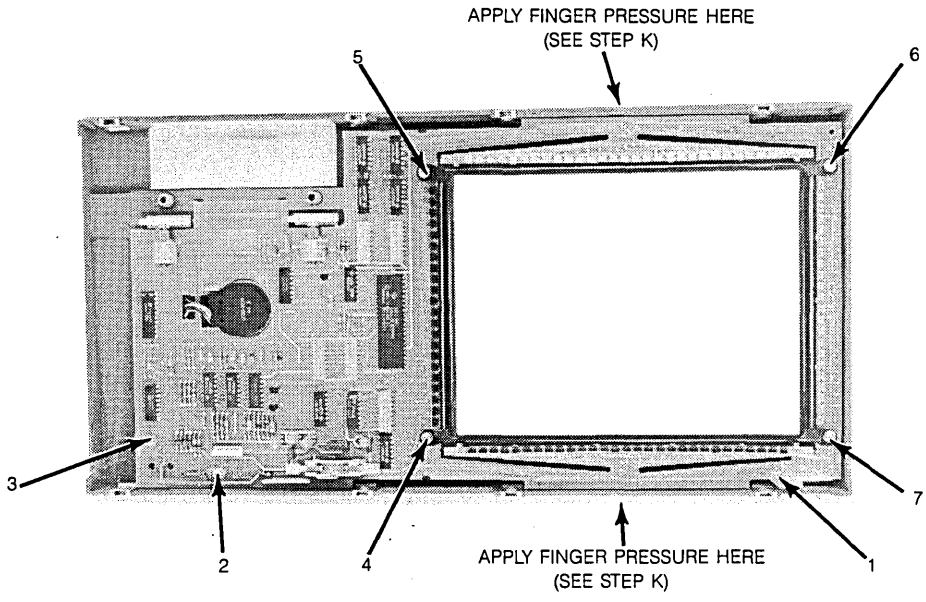

Figure 6-41. Front Panel Board Hardware Identification.

- h. Overlay the new board over the front panel.
- i. Study figure 6-41 and note the number associated with each mounting screw. Install and tighten screws in the same numbered sequence as shown in figure 6-41 and explained in the following steps.
- j. Install a screw at number 1 and leave loose. Install screws at number 2 and 3 and tighten.
- k. Install screws at number 5 and 6. When tightening hardware at number 5 and 6 apply just enough finger pressure so that the board conforms with the curvature of the CRT bezel.
- l. Install screws at number 4 and number 7 and follow the same procedure as in step k.
- m. Realign the board shield over the assembly.
- n. Align front panel assembly with the instruments' casting. Install front panel mounting hardware, starting with the four corners of the frame.
- o. Complete the procedure by reinstalling all modules and covers.

6-15. COLOR MODULE REPLACEMENT

The display module replacement procedure consists of three sections:

1. Removing the module from the mainframe.
2. Preparing the module for installation.
3. Installing the new module in the mainframe.

Removing the Module from Mainframe.

- a. Remove power cord and stand instrument on its right side as viewed from the back of the instrument.
- b. Remove top and bottom covers. Disconnect the two cables from the front panel board.
- c. With a Torx T-15 driver, remove the four bottom front panel mounting screws as shown in figure 6-42. Repeat the procedure for the top mounting screws.

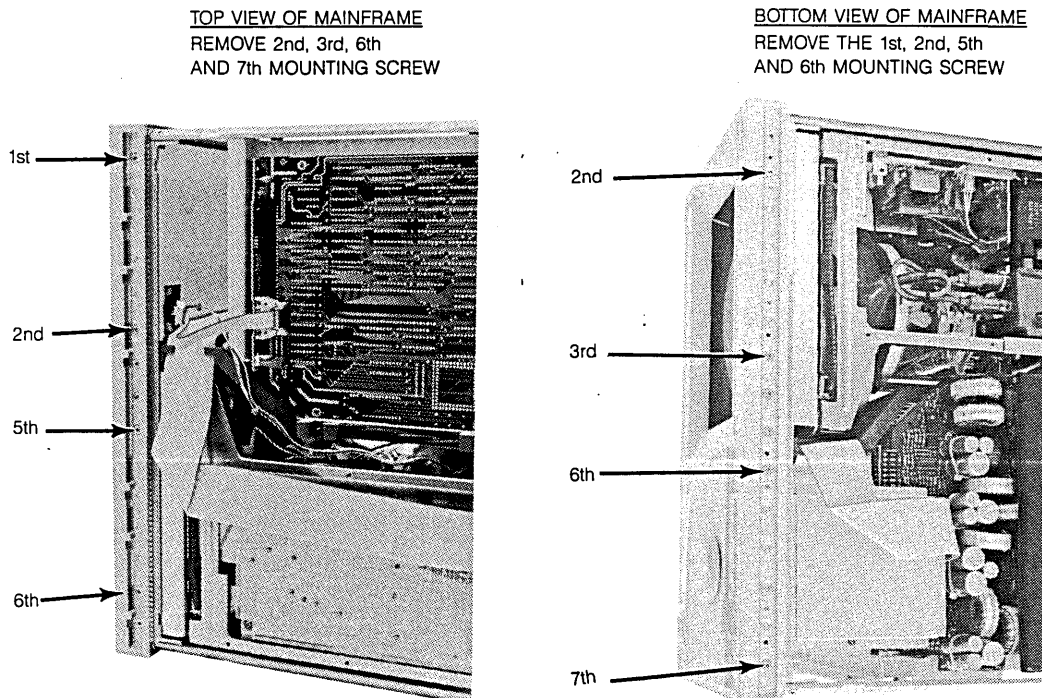

Figure 6-42. Front Panel Mounting Screws Identification

- d. Remove the front panel and shield by pushing on the panel from the inside of the instrument.
- e. Disconnect the module cable from the microprocessor board and module power cable from the power supply. Set instrument on its bottom side.
- f. With a Torx T-10 driver, remove the modules rear mounting bracket screws (see figure 6-43).

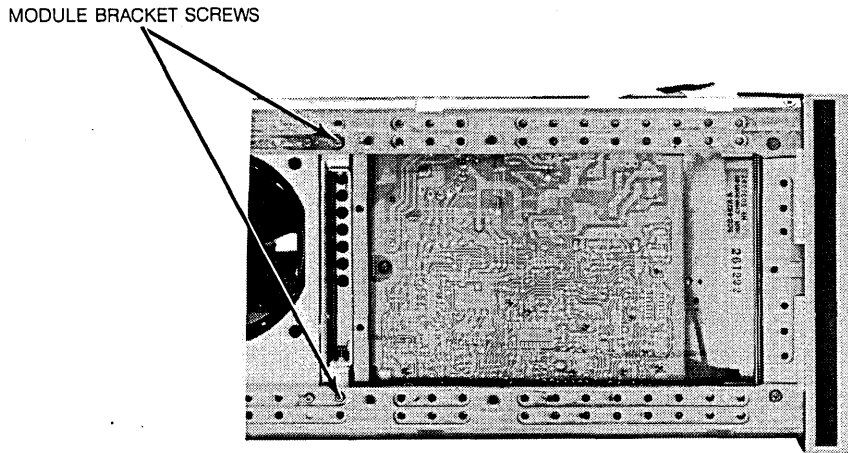

Figure 6-43. Module Bracket Mounting Hardware

- g. Remove the three module mounting screws from top and bottom front casting (total of 6 screws).
- h. Push the sheet metal nut on the center board guide ears upward so that the display module can clear the mainframe (see figure 6-44).

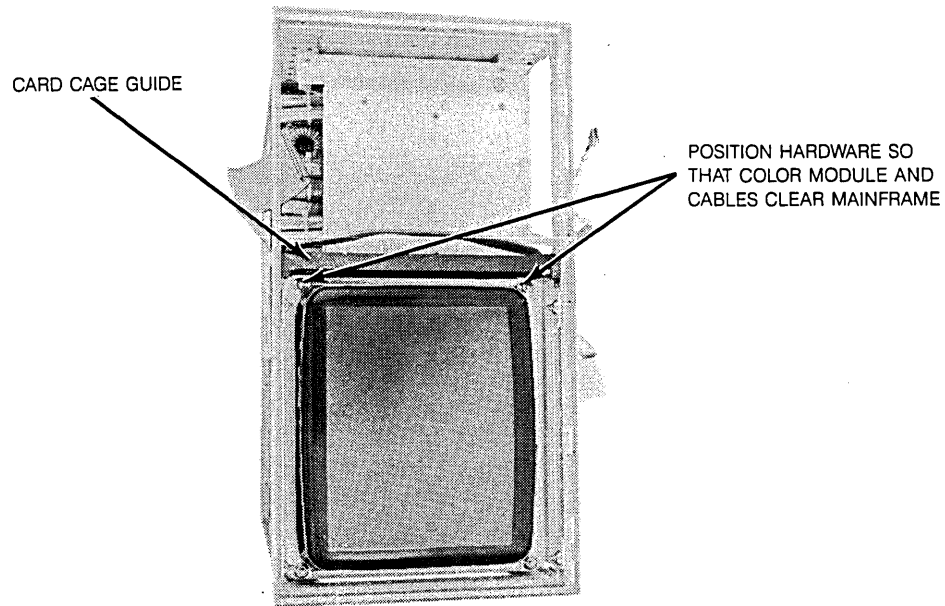

Figure 6-44. Center Board Guide Hardware

- i. Slide the complete module assembly forward out of the mainframe. To prevent damage to the module cables, ensure that they also clear the frame.

Preparing the Module for Reinstallation

The purpose of this procedure is to remove the mechanical parts that are needed by the new module from the old module.

- j. Set the display module on its face (CRT side down) and disconnect the flat microprocessor cable, the power cable and the front panel control cable. Note the location of the cables.
- k. Remove rear mounting bracket with a Torx T-15 driver (see figure 6-45).

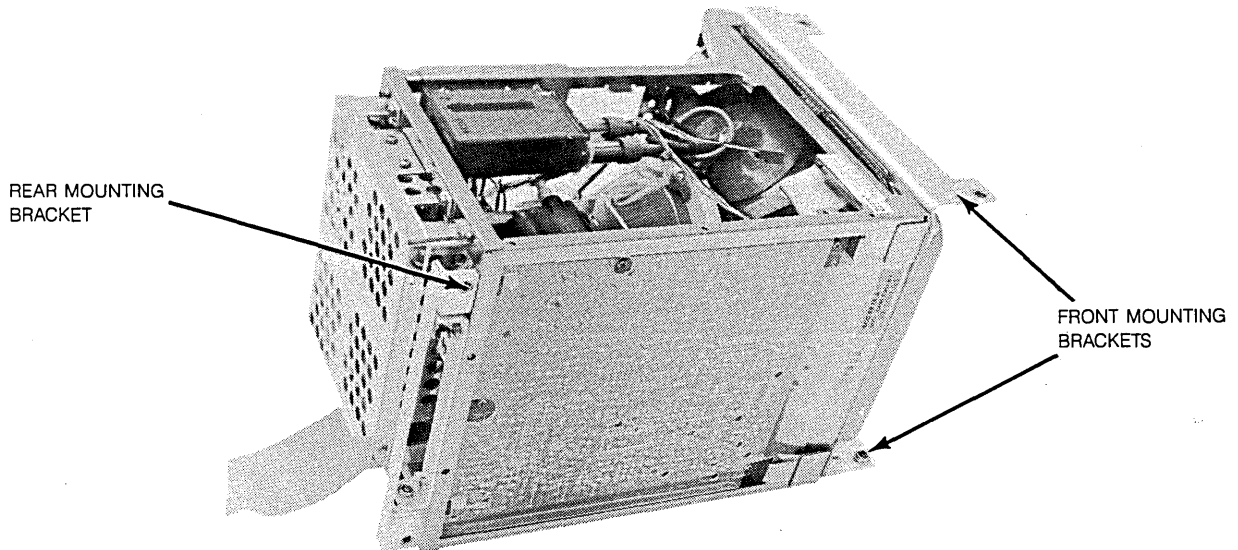

Figure 6-45. Color Module Rear and Front Mounting Bracket

- l. Set module on its rear panel (CRT facing up). With a 5/16 inch nut driver, remove the front mounting brackets from the old module. Reinstall the four bracket nuts on the old module.
- m. Set the replacement module on its rear panel and remove the four bracket nuts with a 5/16 inch nut driver.
- n. Install both mounting brackets on the front of the new module. The upper bracket is identified by the notch in one ear.
- o. Set display module on its bottom side with rear panel facing you. Attach rear mounting bracket to the module. Use the two thread forming screws (see figure 6-46). Do not tighten to more than 18 in/lbs or you will damage the module frame.

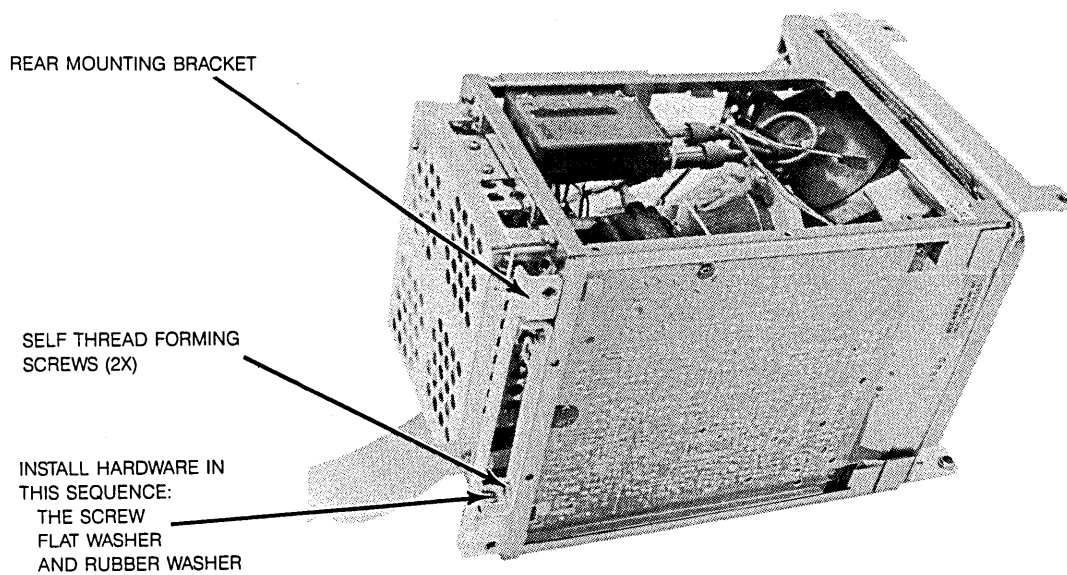

Figure 6-46. Color Module Rear Mounting Bracket Assembly

- p. Attach the frame mounting bracket to the rear module mounting bracket (see figure 6-45). Install hardware in the following sequence: screw, flat washer, rubber washer. Leave the bracket hardware loose. In a later step, when the module is correctly positioned, the hardware will be tightened.
- q. Reconnect the microprocessor cable, the power cable and the front panel control cable.

Installing the Replacement Module

- r. Carefully slide the display module into the mainframe. Ensure that the module mounting bracket ears clear the center board guide hardware.
- s. Bolt the display module to the frame, starting with the four corner screws (two on the top casting, and two on the bottom casting). Do not tighten screws.
- t. Attach front tabs of board cage guide to front frame.
- u. Reinstall front panel assembly starting with the corner mounting screws. Ensure proper seating of front panel assembly before installing hardware. Leave screws loose. Add the rest of the front panel screws and do not tighten.



To prevent damage to the front panel or the knob, support the instrument as described in the next step and as shown in figure 6-47.

- v. Set the instrument on its front panel and elevated it by a 3/4 inch support on the right and the left side of the front panel (see figure 6-47).

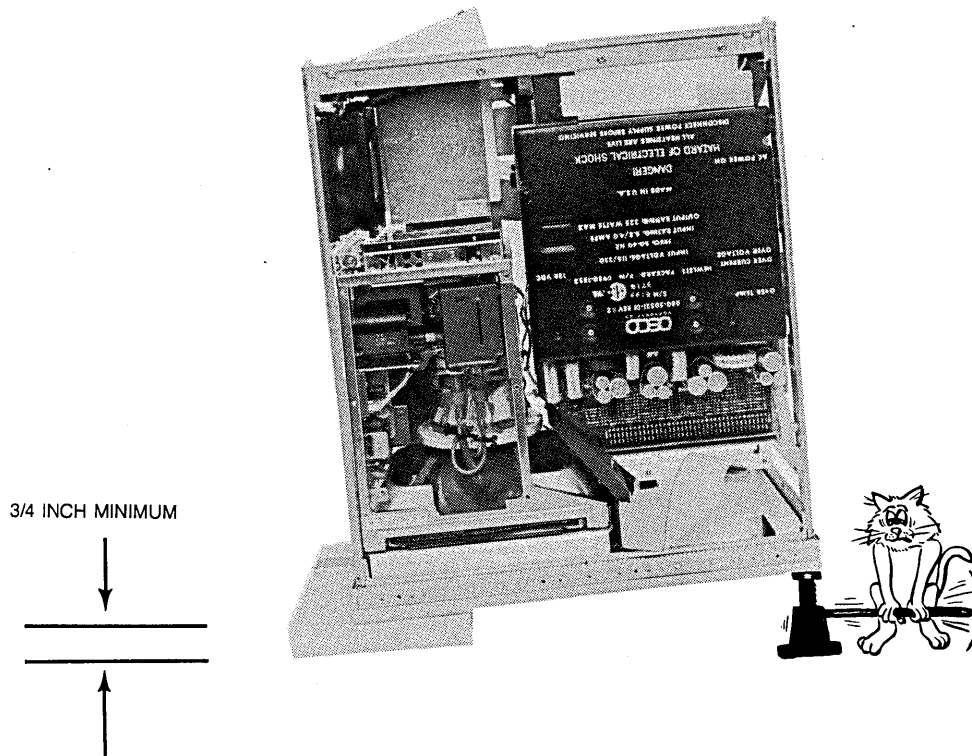

Figure 6-47. Final Positioning of Front Panel and Color Module

- w. Ensure that display module is properly seated against the front panel assembly. Tighten the four display module mounting screws in the front frame.
- x. Attach the rear module mounting bracket to the side frame and tighten the mounting bracket screws. Do not overtighten the screws or you will damage the rubber washer.
- y. Tighten all module mounting hardware. Reconnect microprocessor flat cable, the module power cable, and front panel control cable.
- z. Reinstall all modules and covers.

6-16. FRONT DISC DRIVE REPLACEMENT

- a. Remove power cord and top cover of instrument.
- b. With a Torx T-8 driver, remove the two disc mounting screws (see figure 6-48).

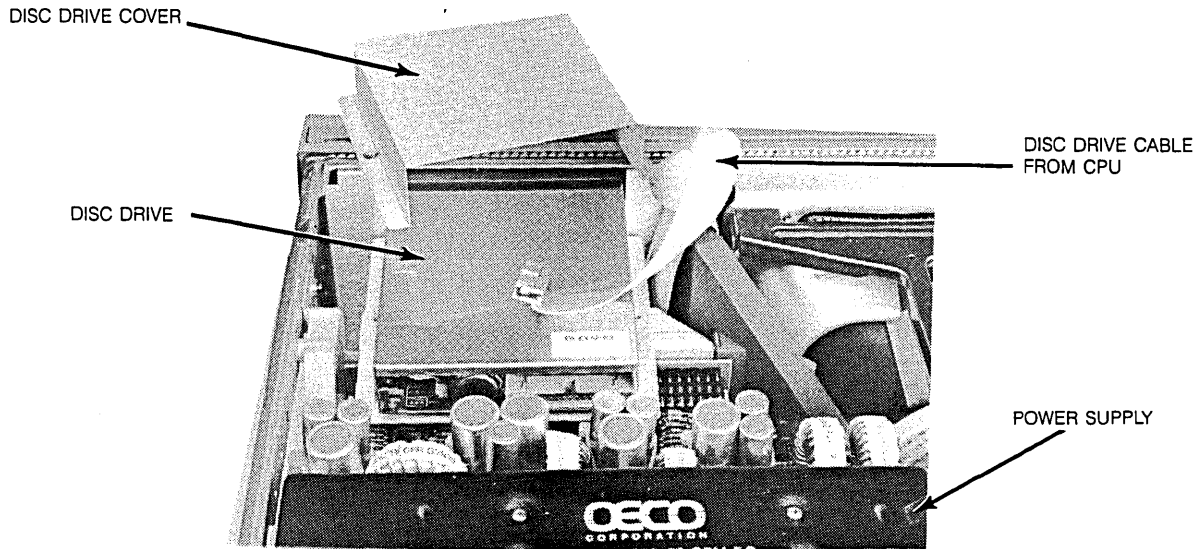

Figure 6-48. Front Disc Removal

- c. Slowly slide the front disc drive assembly toward the rear panel. Remove the disc mounting bracket from bottom of disc.
- d. Disconnect the disc drive cable and connect it to the replacement unit.
- e. Reattach the bottom disc drive bracket to the new drive.
- f. Reinstall the new unit through the front panel. Note the two front panel guide pins (see figure 6-49).

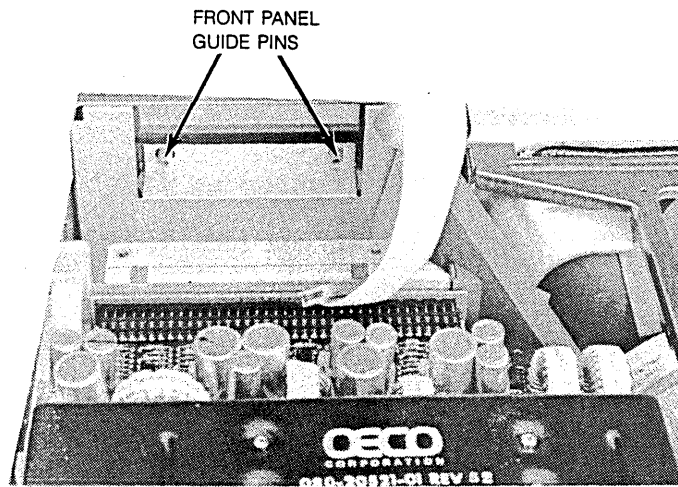

Figure 6-49. Front Disc Drive Replacement

- g. Replace the top disc drive mounting bracket and top cover of instrument.

6-17. REAR DISC DRIVE REPLACEMENT

- a. Remove power cord and bottom cover of instrument.
- b. With a Torx T-8 driver, remove the four disc mounting screws (see figure 6-250).

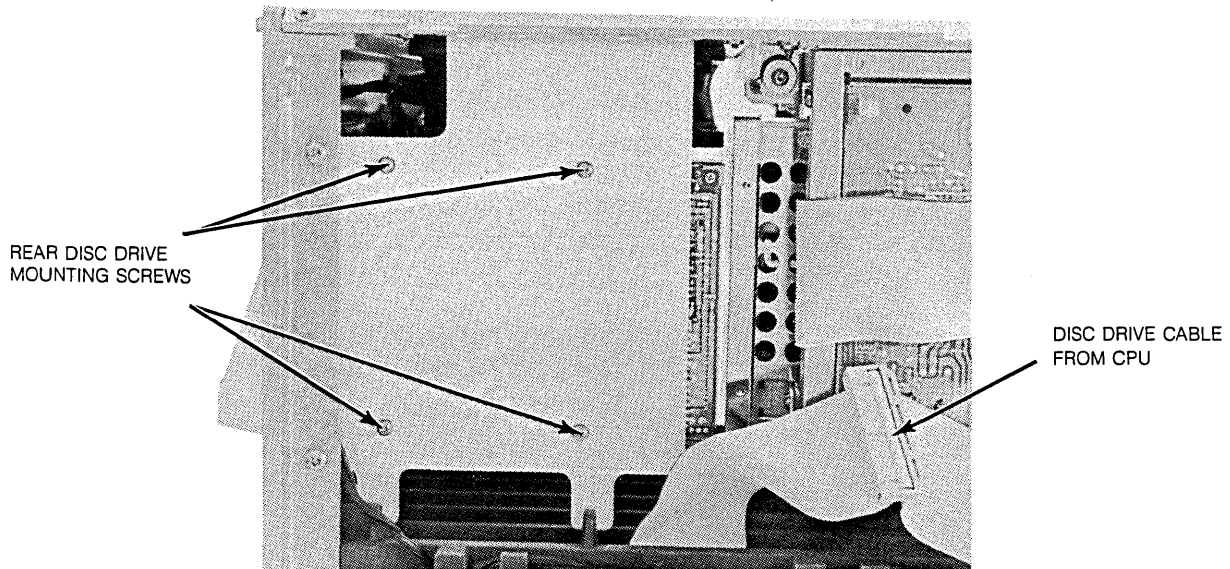

Figure 6-50. Rear Disc Drive Removal

- c. Disconnect the control cable and slide the unit out of the rear panel.
- d. Slide the replacement unit through the rear panel and reinstall the mounting hardware.
- e. Reconnect control cable and replace the bottom cover.

6-18. COOLING FAN REPLACEMENT

Side Fan Replacement

- a. Remove power cord, top, bottom, and right side cover.
- b. With a Torx T-15 driver, remove the four side fan mounting screws (see figure 6-51).
- c. Reach through the top of the instrument and disconnect the fan power cable.

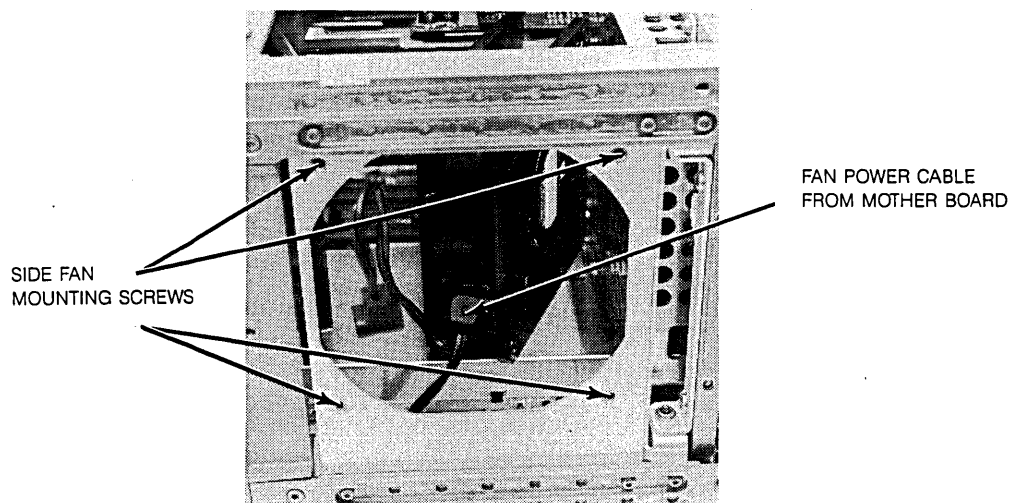

FAN IS SHOWN REMOVED FROM FAN BRACKET

Figure 6-51. Side Fan Mounting Screws and Power Cable Removal

- d. Install the new side fan. Reconnect power cable and dress it between the two fans.

Rear Fan Replacement

- a. Remove power cord and top cover.
- b. With a Torx T-10 driver, remove the complete fan assembly from instrument rear panel (see figure 6-52).

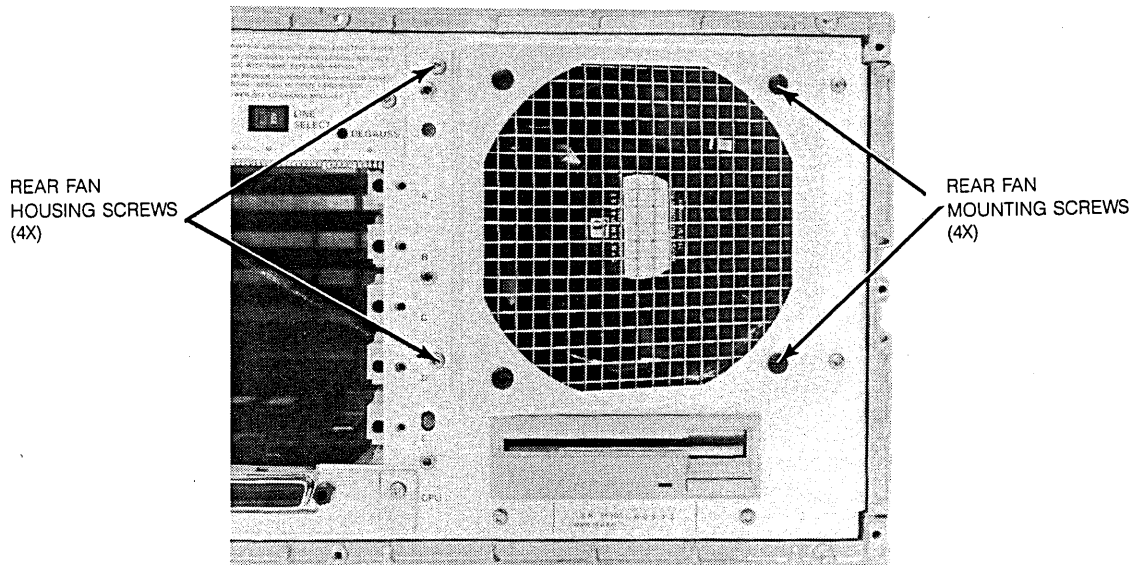

Figure 6-52. Rear Fan Removal

- c. Disconnect fan power cable. With a Torx T-15 driver remove fan from fan bracket.
- d. Reverse the above procedure when installing the new fan. Ensure that the power cable is dressed under and between the fans.

